

# Panasonic<sup>®</sup>

## Color CCTV Camera Operating Instructions

Model No.

# WV-CS954

ENGLISH

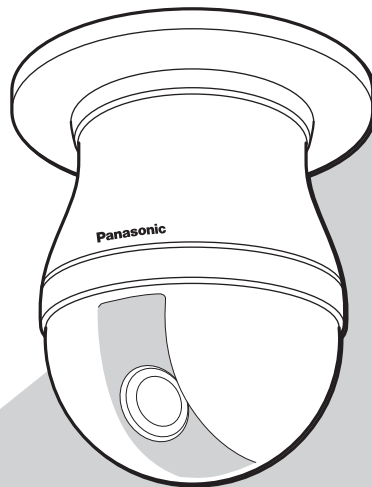

FRANÇAIS

Before attempting to connect or operate this product,  
please read these instructions carefully and save this manual for future use.

# ENGLISH VERSION



**CAUTION**  
RISK OF ELECTRIC SHOCK  
DO NOT OPEN



CAUTION: TO REDUCE THE RISK OF ELECTRIC SHOCK,  
DO NOT REMOVE COVER (OR BACK).  
NO USER-SERVICEABLE PARTS INSIDE.  
REFER SERVICING TO QUALIFIED SERVICE PERSONNEL.

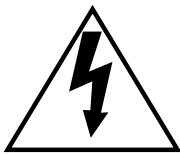

SA 1965

The lightning flash with arrowhead symbol, within an equilateral triangle, is intended to alert the user to the presence of uninsulated "dangerous voltage" within the product's enclosure that may be of sufficient magnitude to constitute a risk of electric shock to persons.



SA 1966

The exclamation point within an equilateral triangle is intended to alert the user to the presence of important operating and maintenance (servicing) instructions in the literature accompanying the appliance.

For U.S.A

**NOTE:** This equipment has been tested and found to comply with the limits for a Class A digital device, pursuant to Part 15 of the FCC Rules. These limits are designed to provide reasonable protection against harmful interference when the equipment is operated in a commercial environment. This equipment generates, uses, and can radiate radio frequency energy and, if not installed and used in accordance with the instruction manual, may cause harmful interference to radio communications.

Operation of this equipment in a residential area is likely to cause harmful interference in which case the user will be required to correct the interference at his own expense.

**FCC Caution:** To assure continued compliance, (example - use only shielded interface cables when connecting to computer or peripheral devices). Any changes or modifications not expressly approved by the party responsible for compliance could void the user's authority to operate this equipment.

For Canada

This Class A digital apparatus complies with Canadian ICES-003.

The serial number of this product may be found on the top of the unit.

You should note the serial number of this unit in the space provided and retain this book as a permanent record of your purchase to aid identification in the event of theft.

Model No.            WV-CS954

Serial No. \_\_\_\_\_

**WARNING:** To prevent fire or electric shock hazard, do not expose this appliance to rain or moisture. The apparatus shall not be exposed to dripping or splashing and that no objects filled with liquids, such as vases, shall be placed on the apparatus.

## IMPORTANT SAFETY INSTRUCTIONS

- 1) Read these instructions.
- 2) Keep these instructions.
- 3) Heed all warnings.
- 4) Follow all instructions.
- 5) Do not use this apparatus near water.
- 6) Clean only with dry cloth.
- 7) Do not block any ventilation openings. Install in accordance with the manufacturer's instructions.
- 8) Do not use near any heat sources such as radiators, heat registers, stoves, or other apparatus (including amplifiers) that produce heat.
- 9) Do not defeat the safety purpose of the polarized or grounding-type plug. A polarized plug has two blades with one wider than the other. A grounding-type plug has two blades and a third grounding prong. The wide blade or the third prong are provided for your safety. If the provided plug does not fit into your outlet, consult an electrician for replacement of the obsolete outlet.
- 10) Protect the power cord from being walked on or pinched particularly at plugs, convenience receptacles and the points where they exit from the apparatus.
- 11) Only use attachments/accessories specified by the manufacturer.
- 12) Use only with the cart, stand, tripod, bracket, or table specified by the manufacturer, or sold with the apparatus. When a cart is used, use caution when moving the cart/apparatus combination to avoid injury from tip-overs.



- 13) Unplug this apparatus during lightning storms or when unused for long periods of time.
- 14) Refer all servicing to qualified service personnel. Servicing is required when the apparatus has been damaged in any way, such as power-supply cord or plug is damaged, liquid has been spilled or objects fallen into the apparatus, the apparatus has been exposed to rain or moisture, does not operate normally, or has been dropped.

## LIMITATION OF LIABILITY

THIS PUBLICATION IS PROVIDED "AS IS" WITHOUT WARRANTY OF ANY KIND, EITHER EXPRESS OR IMPLIED, INCLUDING BUT NOT LIMITED TO, THE IMPLIED WARRANTIES OF MERCHANTABILITY, FITNESS FOR ANY PARTICULAR PURPOSE, OR NON-INFRINGEMENT OF THE THIRD PARTY'S RIGHT.

THIS PUBLICATION COULD INCLUDE TECHNICAL INACCURACIES OR TYPOGRAPHICAL ERRORS. CHANGES ARE ADDED TO THE INFORMATION HEREIN, AT ANY TIME, FOR THE IMPROVEMENTS OF THIS PUBLICATION AND/OR THE CORRESPONDING PRODUCT(S).

## DISCLAIMER OF WARRANTY

IN NO EVENT SHALL MATSUSHITA ELECTRIC INDUSTRIAL CO., LTD. BE LIABLE TO ANY PARTY OR ANY PERSON, EXCEPT FOR REPLACEMENT OR REASONABLE MAINTENANCE OF THE PRODUCT, FOR THE CASES, INCLUDING BUT NOT LIMITED TO BELOW:

- (1) ANY DAMAGE AND LOSS, INCLUDING WITHOUT LIMITATION, DIRECT OR INDIRECT, SPECIAL, CONSEQUENTIAL OR EXEMPLARY, ARISING OUT OF OR RELATING TO THE PRODUCT;
- (2) PERSONAL INJURY OR ANY DAMAGE CAUSED BY INAPPROPRIATE USE OR NEGLIGENT OPERATION OF THE USER;
- (3) UNAUTHORIZED DISASSEMBLE, REPAIR OR MODIFICATION OF THE PRODUCT BY THE USER;

- (4) INCONVENIENCE OR ANY LOSS ARISING WHEN IMAGES ARE NOT DISPLAYED, DUE TO ANY REASON OR CAUSE INCLUDING ANY FAILURE OR PROBLEM OF THE PRODUCT;
- (5) ANY PROBLEM, CONSEQUENTIAL INCONVENIENCE, OR LOSS OR DAMAGE, ARISING OUT OF THE SYSTEM COMBINED BY THE DEVICES OF THIRD PARTY.
- (6) ANY CLAIM OR ACTION FOR DAMAGES, BROUGHT BY ANY PERSON OR ORGANIZATION BEING PHOTOGENIC SUBJECT, DUE TO VIOLATION OF PRIVACY WITH THE RESULT OF THAT SURVEILLANCE-CAMERA'S PICTURE, INCLUDING SAVED DATA, FOR SOME REASON, BECOMES PUBLIC OR IS USED FOR THE PURPOSE OTHER THAN SURVEILLANCE.
- (7) ANY PROBLEM, CONSEQUENTIAL INCONVENIENCE, ANY LOSS OR DAMAGE, ARISING OUT OF THE IMPROPER DETECTION OR SLIP-UP IN DETECTION BY VMD (Video Motion Detector) FUNCTION OF THE PRODUCT.

## FEATURES

This Color CCTV Camera is a video surveillance device that incorporates a 1/4-type {1/4"} CCD, a 30x zoom lens, preset and pan and tilt capabilities in a dome configuration. It also has the following features.

### ■ Super Dynamic III (SUPER-D III)

SUPER-D III makes it possible to capture clear images of subjects whose illumination is extremely different.

### ■ New DSP for High Sensitivity

A new noise reduction system lowers minimum illuminance to 0.5 lux{fc} in the color mode and 0.04 lux{fc} in the black and white mode.

### ■ Auto Nighttime Switching to Black and White Mode

The camera can be configured to switch to the black and white mode automatically under low light conditions for clear images, even at night.

### ■ Digital Flip

Normally, a camera needs to stop when it points straight down during a tilt operation. With digital flip, however, the camera is able to tilt from 0° to 180° in a single motion. This makes it possible to track subjects passing directly under the camera more smoothly.

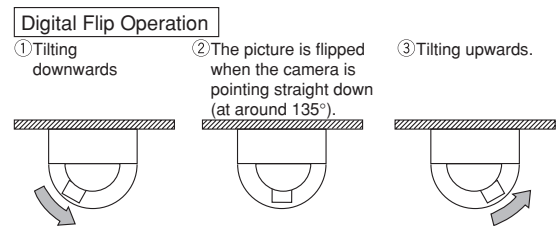

... Digital flip is performed only when the system controller joystick is held downwards.

### ■ Privacy Zone Function

The privacy zone function makes it possible to mask specific areas of the scene from view.

### ■ Patrol Function

The patrol function remembers manual camera movement routines for automatic playback when they are needed. For example, you can teach the camera the movements of the people you want to monitor, by replaying the stored parameters complicated movements are done automatically.

### ■ Camera Position Memory

The system can be configured with up to 256 camera positions. A particular camera position can be selected and viewed by entering the applicable preset number on the system controller 10-key pad.

### ■ Motion Detection

The system can be configured so any motion on the monitor screen during surveillance causes output of an alarm signal.

This function can be used to structure a system with a VCR that records images of nighttime intruders.

## ACCESORIES

Operating Instructions (this manual) . . . . . 1 pc.  
Warranty Certificate . . . . . 1 pc.

The following items are for installation.

Decorative Cover . . . . . 1 pc.  
Dust Protection Sheet . . . . . 1 pc.  
8P Alarm Cable . . . . . 1 pc.  
4P Alarm Cable . . . . . 1 pc.  
Connector for 24 V AC . . . . . 1 pc.

## OPTIONAL ACCESORIES

Dome Cover(approx.50 % transparency,smoked type) . . . . . WV-CS3S  
Ceiling Mount Bracket . . . . . WV-Q105/WV-Q116/WV-Q117  
Wall Mount Bracket . . . . . WV-Q118

## PRECAUTIONS

### 1. Do not attempt to disassemble the camera.

To prevent electric shock, do not remove screws or covers.

There are no user-serviceable parts inside.

Ask qualified service personnel for servicing.

### 2. Handle the camera with care.

Do not misuse the camera. Avoid striking, shaking, etc. The camera could be damaged by improper handling or storage.

### 3. Do not expose the camera to rain or moisture, nor try to operate it in wet areas.

This product is designed for indoor use or locations where it is protected from rain and moisture.

Turn the power off immediately and ask qualified service personnel for servicing.

Moisture can damage the camera and also create the danger of electric shock.

### 4. Do not use strong or abrasive detergents when cleaning the camera body.

Use a dry cloth to clean the camera when it is dirty.

When the dirt is hard to remove, use a mild detergent and wipe gently. Care should be taken not to scratch the dome cover when wiping it.

Afterwards, wipe off the remaining detergent with a dry cloth.

### 5. Never aim the camera at the sun.

Whether or not the camera is in use, never aim it at the sun or other extremely bright objects. Otherwise, blooming or smear may be caused.

### 6. Never aim the camera at strong light sources for an extended period of time.

A light source such as a spot light causes burn-in on the display screen. Failure to observe this may cause the image to become discolored due to deterioration of the color filter in the CCD.

### 7. Do not install this camera upside down.

This camera is designed for mounting on the ceiling or wall. Using this camera installed upside down, for example, mounted on the floor, may cause malfunction.

### 8. Do not operate the camera beyond the specified temperature, humidity or power source ratings.

Do not use the camera in an extreme environment where high temperature or high humidity exists. Do not place the camera near heat sources such as radiators, stoves or other units that produce heat.

Use the camera under conditions where temperature is between  $-10^{\circ}\text{C}$  -  $+50^{\circ}\text{C}$   $\{14^{\circ}\text{F}$  -  $122^{\circ}\text{F}\}$ , preferably  $+40^{\circ}\text{C}$   $\{104^{\circ}\text{F}\}$ , and humidity is below 90 %.

The input power source is 24 V AC 60 Hz.

### 9. Do not install the camera near the air outlet of an air conditioner.

The lens may become cloudy due to condensation if the camera is used under the following conditions.

- Rapid temperature fluctuations by switching the air conditioner on and off.
  - Rapid temperature fluctuations due to frequent door opening and closing.
  - Use in an environment where eyeglasses become foggy.
  - Use in a room filled with cigarette smoke or dust.
- If the lens becomes cloudy due to condensation, remove the dome cover and wipe all moist surfaces with a soft cloth.

### 10. Consumables

Parts having contacts such as the lens-drive motors, cooling fan motor and slip-rings inside the camera are subject to wear with time. Please ask the nearest service center about replacement and maintenance of such parts.

### 11. Do not aim the camera at the same object for a long time.

Burn-in of an image may be caused on the fluorescent screen of CRT.

### 12. Self-diagnosis Function

If the camera continues operating abnormally for 30 seconds or more due to such an accident as external noise, the camera will automatically reset its power. In the case it happens frequently, check if there would be any environmental cause.

- \* Matsushita Electric Industrial Co., Ltd. herewith declares that it will not be liable for any damage, whether direct or indirect, caused by using the product for business transaction or security, or malfunctioning of this product.

## OPERATING PRECAUTIONS

### ■ The camera does not have a power switch

Power turns on as soon as the power cord is plugged into a power outlet. Before cleaning the camera, unplug the power cord from the power outlet.

### ■ What to do if OVER HEAT appears on the display

This message indicates that the interior of the camera has become very hot. Immediately unplug the power cord from the power outlet, and contact a qualified service person or system installer.

### ■ Note the following to ensure long-term trouble-free operation

Long operation under high temperatures and high humidity can cause components to deteriorate and shorten camera life.

The recommended ambient operation temperature is less than +35 °C.

Make sure the camera is installed in a location where it is not directly exposed to heat from a radiator, heater, etc.

### ■ Avoid use of this camera in a food preparation area and other locations where there are large amounts of steam vapor and oil.

### ■ About the Camera Cleaning Function

Prolonged use can lead to noise on the monitor and divergence of preset positions.

If such conditions persist even after you perform camera cleaning (page 35), use the special setup menu to execute the "REFRESH" operation (page 39).

### ■ This camera is designed for use in a hanging configuration only.

Do not use it in an upright configuration on a tabletop, floor, etc. Such conditions create the risk of malfunction.

### ■ CCD color filter burn-in

Intense light concentrated on one spot for a long period can cause deterioration of the CCD internal color filters, and discoloration of the affected part. Even if the camera position is changed from a fixed position, the discoloration at the previous location of the concentrated light will remain on the screen.

### ■ Do not point the camera at a strong light source.

Intense light such as that produced by a spotlight concentrated on one part of the screen can cause blooming (rainbow around the strong light) or smearing (vertical stripes above and below the strong light).

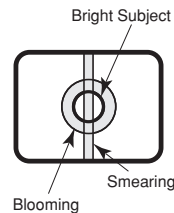

### ■ Do not aim the camera at the same object for a long time.

Burn-in of an image may be caused on the fluorescent screen of CRT.

### ■ Handle the camera carefully.

Do not drop the camera, or subject it to strong impact or vibration. Such conditions create the risk of malfunction.

### ■ Do not allow the camera to become wet.

Make sure that it is not exposed directly to water. Such conditions create the risk of malfunction.

### ■ Condensation inside of the dome cover

Remove the dome cover and use a soft cloth to wipe off the moisture (page 10).

### ■ Consumables

Parts having contacts such as the lens-drive motors, cooling fan motor and slip-rings inside the camera are subject to wear with time. Please ask the nearest service center about replacement and maintenance of such parts.

### ■ Cleaning the camera

Turn off the camera and wipe it with a soft cloth. If the camera is very dirty, wipe it off gently with a soft cloth moistened with a weak solution of water and a neutral kitchen detergent. Wring all excess liquid from the cloth before wiping the camera. Next, wipe off all remaining solution with a soft, dry cloth.

A dirty dome cover or lens causes deterioration of picture quality. Use lens cleaning paper (like the type available for cleaning eyeglasses or a camera lens) to clean the lens.

The dome cover is particularly susceptible to damage. Gently wipe it with a soft cloth.

## ■ Downloading (saving) or uploading (recovering) camera setting information

Camera setting information that can be downloaded to the system controller etc, includes existing preset position settings and menu settings. However, the following items are not included.

- Patrol function (page 32)
- Area title function (page 34)
- Blemish compensation pattern (page 39)
- RS485 settings (page 20)
- Password settings (page 42)

Be sure the camera is not moving and aimed at something that moves very little (like a wall) before downloading camera preset data to the system controller etc. or uploading downloaded data to the camera.

Uploading of WV-CS954 preset data to other models (e.g. WV-CS854, WV-CS854A, WV-CS854B and WV-NS324) may cause an error and failure of the uploading process.

## ■ Self-diagnosing Function

If abnormal operation due to external noise or some other reason continues for more than 30 seconds, the camera will automatically reset itself and restore normal operation. Reset operation the same initialization routine that is performed when the camera is turned on. If the reset is required too often, it could mean that the camera is installed in a location where there is a large amount of external noise. This can cause malfunction of the camera, so you should contact a qualified service person or system installer as soon as possible.



# CONTENTS

IMPORTANT SAFETY INSTRUCTIONS	3
LIMITATION OF LIABILITY	4
DISCLAIMER OF WARRANTY	4
FEATURES	5
■ Super Dynamic III (SUPER-D III)	5
■ New DSP for High Sensitivity	5
■ Auto Nighttime Switching to Black and White Mode	5
■ Digital Flip	5
■ Privacy Zone Function	5
■ Patrol Function	5
■ Camera Position Memory	5
■ Motion Detection	5
ACCESORIES	5
OPTIONAL ACCESORIES	5
PRECAUTIONS	6
OPERATING PRECAUTIONS	7
CONSTRUCTION	10
INSTALLATION PRECAUTIONS	11
DIP SWITCH SETTINGS	12
■ Communication Parameters (DIP Switch 2)	12
■ Unit Number (DIP Switch 1)	13
■ RS485 Communication Parameters (DIP Switch 1)	14
CAMERA INSTALLATION	15
■ Preparing the Camera and Decorative Cover for Side Cable Exit	15
■ Installing the Camera	15
UNINSTALLING THE CAMERA	17
■ Decorative Cover	17
■ Uninstalling the Camera	17
CONNECTIONS	18
RS485 SETUP	20
USING THE SETUP MENU	21
■ Displaying the Setup Menu	21
■ Language Setting	21
CAMERA SETTINGS	22
■ Using the Camera Setup Menu	22
PAN / TILT	27
■ Using the Pan/Tilt Setup Menu	27
ALARM SETTINGS	36
■ Using the Alarm Setup Menu	36
SPECIAL SETTINGS	39
■ Using the Special Setup Menu	39
SCENE SELECT SETTING	40
■ Using the Scene Select Setting Menu	40
QUICK MENU SETTINGS	41
■ Displaying the Quick Setup Menu	41
PASSWORD SETTINGS	42
■ Password Lock Settings	42
SHORTCUTS	44
TROUBLESHOOTING	46
SPECIFICATIONS	50

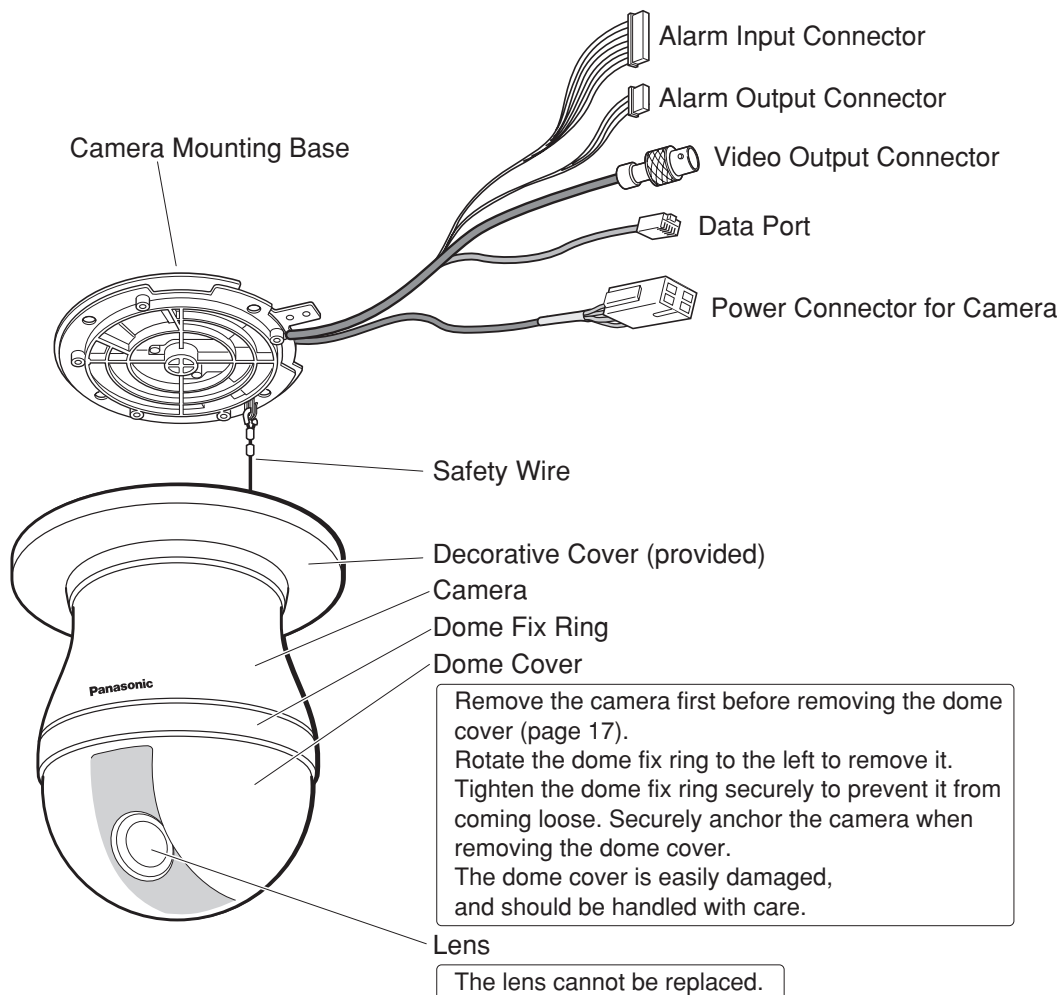

## Ensuring Trouble-free Operation

- This camera uses a “slip ring” for transmission of electrical power and signals. A dirty slip ring can cause deterioration of picture quality during panning and generation of noise.  
 In order to ensure trouble-free camera operation, make sure that the cleaning function (page 35) is turned on.
- If cleaning the slip ring does not eliminate poor picture quality and noise, it could mean that the slip ring has reached the end of its service life. Contact a qualified service person or system installer to have it replaced.

## INSTALLATION PRECAUTIONS

**Warning:** Discuss the installation location for the camera with your retailer, and select a place that is strong enough for the installation. If you install the camera on a ceiling or wall, except for accidents caused by fault in the camera, Panasonic holds absolutely no responsibility for accidents caused by the camera falling due to unsuitable installation. Take sufficient care when installing the camera. If the installation is not strong enough, be sure to sufficiently reinforce the location and check that it is safe.

**Warning:** Always request installation work from a qualified service person or system installer. Lack of technical knowledge creates the risk of fire, electric shock, personal injury, and material damage.

### ■ Camera Installation Location

- Install the camera on a ceiling (concrete, etc.) at a location that is sufficiently strong to support it.
- When installing the camera on a ceiling of insufficient strength (like a drop ceiling), use the optionally available WV-Q105 Direct Attachment Ceiling Mounting Bracket or the WV-Q116 Embedded Ceiling Mount Bracket.
- For ceiling mounting, use the optionally available WV-Q117 Ceiling Mount Bracket.
- For wall mounting, use the optionally available WV-Q118 Wall Mount Bracket.

■ **This camera is an indoor camera. It is not designed for outdoor use.**

■ **This camera is designed for use in a hanging configuration only. Using it in an upright or inclined configuration can cause malfunction and shorten the life of the camera.**

■ **Install the camera in a horizontal configuration, with the dome pointed downwards.**

■ **Never install or use the camera in the following locations.**

- Areas directly exposed to rain and water
- Near a swimming pool or other areas where chemicals are used
- Food preparation areas and other locations where there are large amounts of steam vapor and oil, in flammable atmospheres, other special environments
- Areas where radiation, X-rays, strong electric waves, or magnetism is generated
- At sea, in coastal areas, or in areas where corrosive gas is being generated
- Areas outside of the allowable ambient operating temperature range (-10 °C to +50 °C {14 °F to 122 °F})

- In a motor vehicle, on a boat, or other areas subject to strong vibration (This camera is not designed for use in a vehicle.)
- Near an air conditioner outlet, near a door that opens up to the outdoors, or any other area subjected to temperature extremes (Such conditions can cause clouding and condensation formation on the dome cover.)

■ **When wiring the camera, its cables (power, video output, RS485, alarm in, alarm out) can exit out the side or the top of the camera.**

- When using the top cable exit configuration, drill a hole in the ceiling to allow passage of the cables. (See step 3 on page 15.)
- When using the side cable exit configuration, prepare the cutout in the die cast case and decorative cover. (See "Preparing the Camera and Decorative Cover for Side Cable Exit" on page 15.)

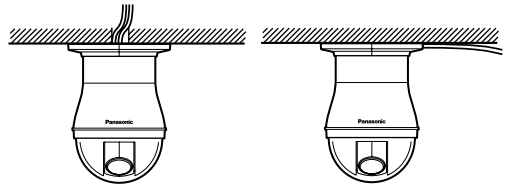

### ■ Noise interference considerations

When using a power line that is greater than 120 V AC and wiring that is longer than 1 meter, wiring should be performed using a separate metal conduit. (The metal conduit must be earth grounded.)

■ **Screws should be ordered separately.**

The camera does not come with screws. Make sure that the materials and structure of the installation location is strong enough to support the total weight of the camera.

### Important:

- **Before setting up the camera for a configuration where the camera's RS485 data port is used for camera control (pan, tilt, etc.) by the system controller, the camera's DIP switches must be configured to specify the unit number and communication parameters. (page 12)**

**If DIP switch setting is not performed, the system controller control will not be possible and camera setup will have to be performed again. Be sure to check the DIP switch settings before setting up the camera.**

**Notes:**

- If you need to connect a ground, be sure to do it before you connect the main power plug. Also, when removing the ground, be sure to disconnect the main power plug.
- The camera does not have a power switch, so it turns on as soon as the power cord is plugged into a power outlet. A self-cleaning function is activated (PAN/TILT/ZOOM/FOCUS) when the camera is turned on.

**■ Heat radiation**

The surface of the camera radiates heat. Ventilation holes should be provided when installing the camera in an enclosed ceiling or confined location where heat can build up.

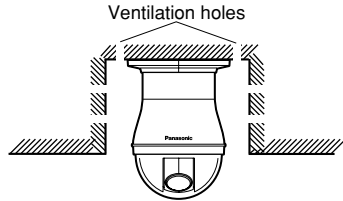

**■ Beware of high humidity.**

If the camera is installed when humidity is very high, moisture may collect in the camera and cause the dome to become foggy. If the dome becomes foggy, remove it when the humidity is low and eliminate the moisture inside the camera, and then replace the dome. (page 7, 10)

## DIP SWITCH SETTINGS

In a configuration where the camera's RS485 data port is used for camera control (pan, tilt, etc.) by the system controller, the camera's DIP switches must be configured to specify the unit number and communication parameters. The camera mounting base needs to be removed to access the DIP switches. See steps 1 and 2 on page 15 for information about how to remove the camera mounting base.

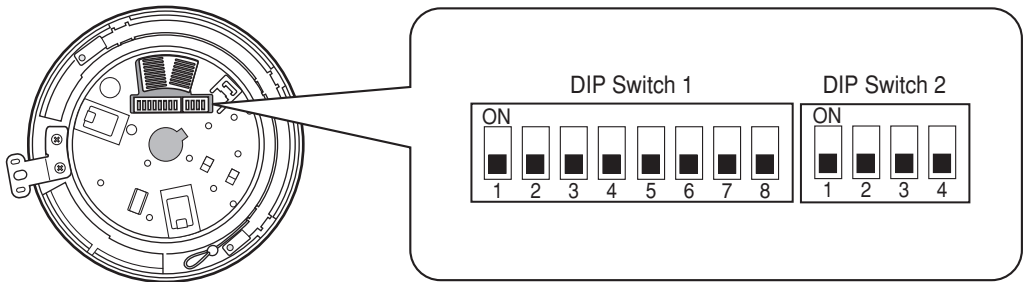

### ■ Communication Parameters (DIP Switch 2)

The factory default settings of these DIP switches are all OFF.

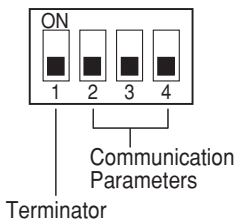

**Switch 1:** Terminator (Internal Termination Resistance)

Set it to ON in the following situations.

- When only one camera is connected.
- When only one camera is connected via a daisy chain over a long distance.

**Switches 2 through 4:** Communication Parameters

This setting toggles between 2-line and 4-line communication. Use these switches to select the communication protocol being used.

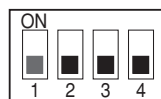



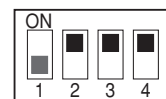

































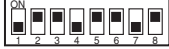













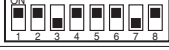

















4-line Communication













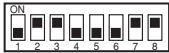

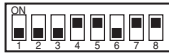

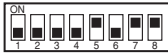

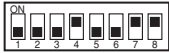

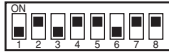

2-line Communication

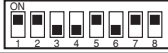
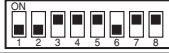
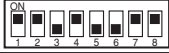
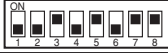
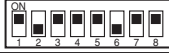
## ■ Unit Number (DIP Switch 1)

The factory default settings of these DIP switches are all OFF. (Coaxial Multiplex System)





DIP Switch 1	Unit Number	DIP Switch 1	Unit Number	DIP Switch 1	Unit Number
	1 ~ 96 *		23		46
	1		24		47
	2		25		48
	3		26		49
	4		27		50
	5		28		51
	6		29		52
	7		30		53
	8		31		54
	9		32		55
	10		33		56
	11		34		57
	12		35		58
	13		36		59
	14		37		60
	15		38		61
	16		39		62
	17		40		63
	18		41		64
	19		42		65
	20		43		66
	21		44		67
	22		45		68

DIP Switch 1	Unit Number	DIP Switch 1	Unit Number	DIP Switch 1	Unit Number
	69		78		87
	70		79		88
	71		80		89
	72		81		90
	73		82		91
	74		83		92
	75		84		93
	76		85		94
	77		86		95

- \* When using the Unit Number 1 to 96 setting, the unit number setting needs to be configured using the RS485 SET UP menu. For details about configuring this setting, see step 2 and page 20.
- \* Turning on power when this setting is selected causes the RS485 SET UP menu to appear during the initialization routine.

## ■ RS485 Communication Parameters (DIP Switch 1)

Configuring DIP Switch 1 as shown below resets communication parameters to their factory default settings. You can then change the settings as desired.

DIP Switch 1	Setting Description
	This setting resets communication parameters to the factory default settings.
	BAUD RATE : 19 200 bit/s, DATA BIT : 8 bit, PARITY CHECK : NONE, STOP BIT : 1 bit
	BAUD RATE : 9 600 bit/s, DATA BIT : 8 bit, PARITY CHECK : NONE, STOP BIT : 1 bit
	BAUD RATE : 4 800 bit/s, DATA BIT : 8 bit, PARITY CHECK : NONE, STOP BIT : 1 bit

Perform the following steps to use this setting.

- (1) Turn off the camera and use DIP Switch 1 to configure RS485 communication parameters as shown above.
- (2) Turn on the camera.  
This applies the setting you configured in step (1).
- (3) Turn off the camera, use DIP Switch 1 to set the unit number (pages 13 and 14), and then turn the camera back on again.

# CAMERA INSTALLATION

## ■ Preparing the Camera and Decorative Cover for Side Cable Exit

The camera and decorative cover should be prepared as shown below when mounting the camera on a ceiling or wall with its cables (power, video output, RS485, alarm in, alarm out) exiting from the side.

The camera mounting base needs to be removed in order to prepare the camera. See steps 1 and 2 below for information about how to remove the camera mounting base.

\* Prevent the dome cover from being scratched by placing it on a soft cloth while you are working.

Preparing the Camera Die Cast Case\*

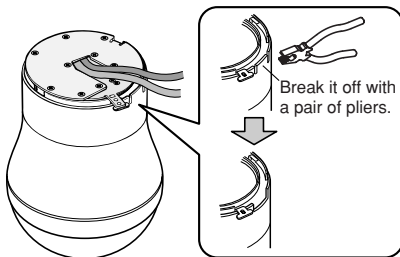

Preparing the Decorative Cover

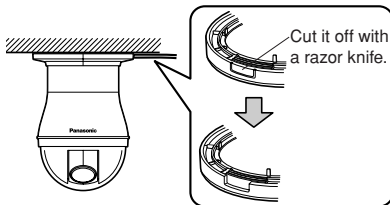

## ■ Installing the Camera

- Select an installation location that is strong enough to withstand the total weight of the camera. Installing the camera at a location that is too weak can cause it to fall.
  - Remove the protection sheet after the installation work is complete.
  - If you are using an optional bracket to install the camera, install the bracket in accordance with the instructions that come with it.
1. Remove the fixing screw (M3 × 6) that secures the camera to the mounting base. Put the screw in a place where it will not become lost.

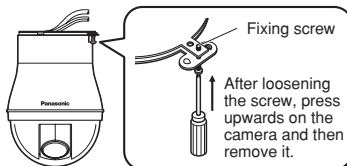

2. Rotate the camera base unit in the direction indicated by the arrow and remove it.

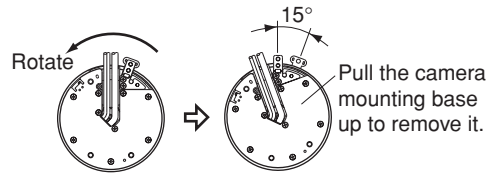

3. Using the camera mounting base as a template, mark the locations of the four mounting holes on the ceiling.

If you are using the top cable exit configuration, mark the location of the cable hole on the ceiling and drill the hole.

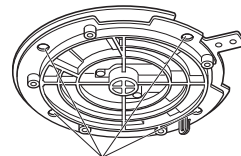

4. Affix the camera mounting base onto the ceiling. Use screws (M4) at the locations you marked above to secure the mounting base to the ceiling. If you do not plan to install the camera right away, affix the dust protection sheet that comes with the camera to the mounting base to keep dust off of it.

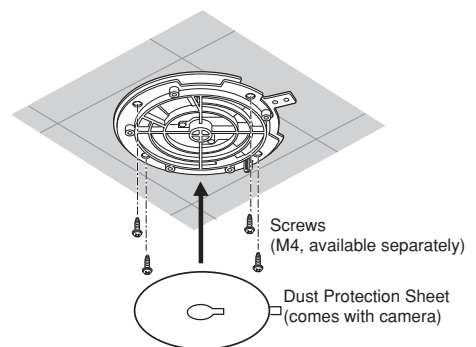

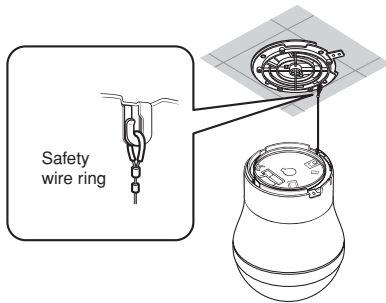

- Attach the safety wire for securing the camera to the mounting base.  
Pull on the safety wire to make sure its ring is securely connected to the mounting base hook.  
If the dust protection sheet that comes with the camera is affixed to the mounting base, remove it before performing the above step.

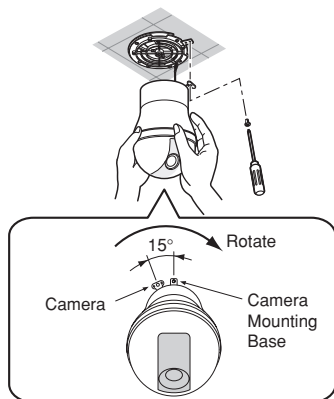

**Note:** The safety wire is designed to allow the camera to hang from it. Do not apply force greater than the weight of the camera to the wire.

- Install the camera onto the mounting base.  
Aligning with the mounting base, press down on the camera as far as it will go and rotate in the direction indicated by the arrow.
- Use the fixing screw you removed in step 1 to secure the camera to the mounting base.
- Check the installation.
  - Is the camera level and installed securely?
  - Is the camera free of looseness?
  - Does the fixed part of the camera remain in place when you try to rotate it?



- Separate the two parts of the decorative cover (comes with camera).  
Press upwards on the decorative cover at the points marked  (indicated by the arrows, in the illustration below) to unhook the two parts from each other.  
\* When removing the decorative cover, the direction to press () is shown on the side of the decorative cover.

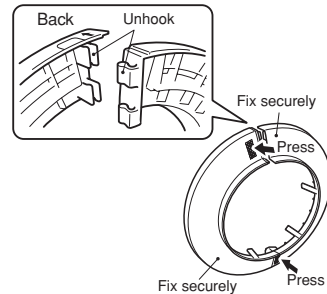

**Caution:** Pressing up on the wrong side of the decorative cover can damage it.

- Put the two pieces of the decorative cover on the left and right side of the camera, and hook them together.  
Align the hooks and press the piece indicated by the arrow in the illustration below into the other piece.

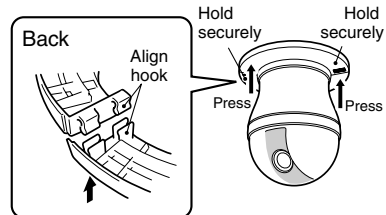

- Slide the decorative cover up to the ceiling.
  - In the case of a top cable exit configuration, slide the decorative cover straight up and press it firmly against the ceiling.
  - In the case of a side cable exit configuration, align the cutout in the decorative cover with the cables as you slide it up, and press it firmly against the ceiling.

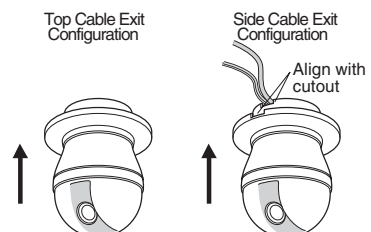





## UNINSTALLING THE CAMERA

**Caution:** Make sure you perform the steps below carefully and exactly when uninstalling the camera and decorative cover. Failure to do so creates the risk of damage to the camera.

### ■ Decorative Cover

Note that you need to separate the two parts of the decorative cover in order to remove it.

1. Unhook the two parts of the decorative cover.  
Press upwards on the decorative cover at the points marked  (indicated by the arrows, in the illustration below) to unhook the two parts from each other.
- \* When removing the decorative cover, the direction to press (  ) is shown on the side of the decorative cover.

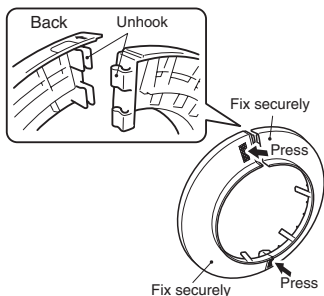

### ■ Uninstalling the Camera

The camera and its base unit are secured by screws. This configuration provides double anchoring, and you should use the following procedure to uninstall the camera.

1. Remove the fixing screw that secures the camera to the mounting base.  
Put the screw in a place where it will not become lost.
2. Remove the camera from the mounting base.  
Rotate the camera in the direction indicated by the arrow and remove it.

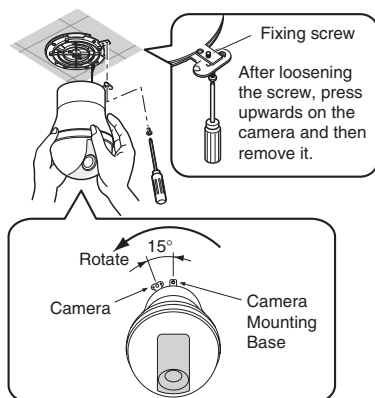

3. Remove the safety wire from the mounting base.

# CONNECTIONS

## Precautions

- The following connections should be made by qualified service personnel or system installers in accordance with all local codes.
- See the reverse side of the cover page for main lead connection.

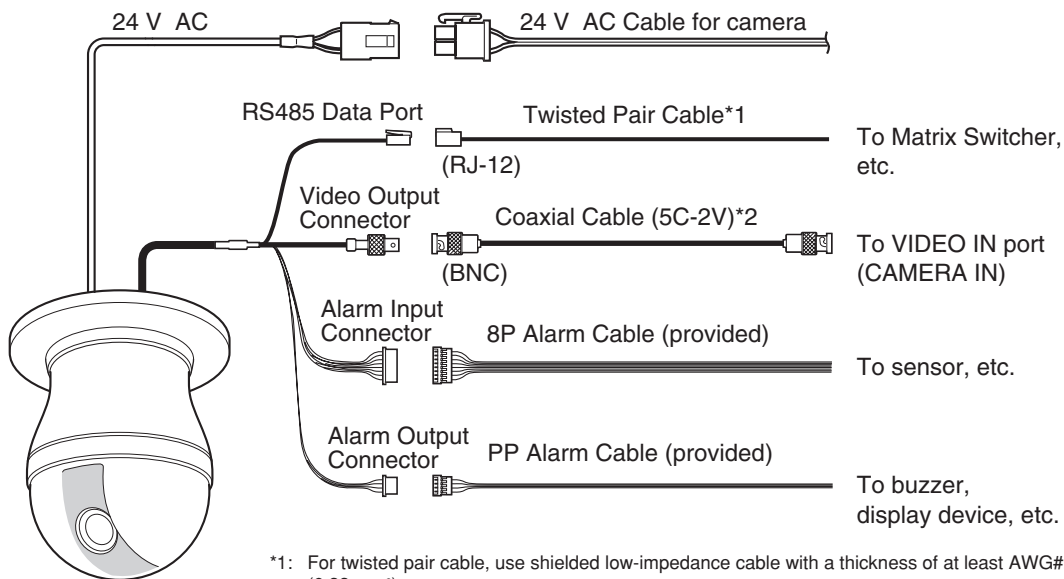

\*1: For twisted pair cable, use shielded low-impedance cable with a thickness of at least AWG#22 (0.33 mm<sup>2</sup>).

\*2: Keep the overall length of coaxial cable under 1200 meters (in the case of 5C-2V).

\*3: Be sure to connect the grounding cable to ground.

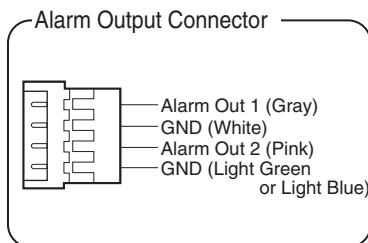
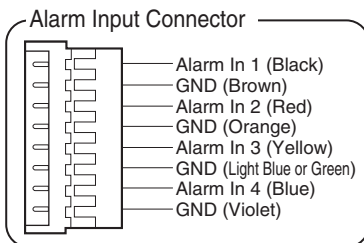
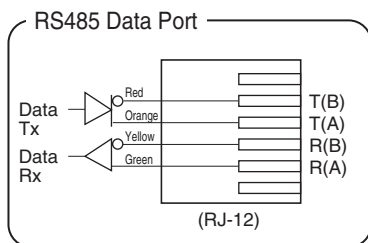

## Alarm In/Out Ratings

**Alarm In** : 5 V DC pull-up input. Drive capacity of at least 0.2 mA required.

**OFF** : 4 V DC minimum 5 V DC maximum, or open

**ON** : 1 V DC maximum or short

**Alarm Out** : Open collector output. 16 V DC, 100 mA maximum drive capacity

**OFF** : Open

**ON** : 100 mA maximum

\* When connecting to an external device, set up the system so the ratings are not exceeded.

**Note:** Do not turn off camera power within 30 seconds after turning it on. Doing so can cause pan, tilt, zoom, or focus to go out of position.

## 24 V AC Power Supply Connection

### Recommended wire gauge sizes for 24 V AC line

Copper wire size (AWG)	#24 (0.22mm <sup>2</sup> )	#22 (0.33mm <sup>2</sup> )	#20 (0.52mm <sup>2</sup> )	#18 (0.83mm <sup>2</sup> )	
Length of cable (approx.)	(m)	20	30	45	75
	(ft)	65	100	160	260

### Accessory Connector Information

Pin no.	Power source
1	24 V AC LIVE
2	24 V AC NEUTRAL
3	Ground
4	Not use

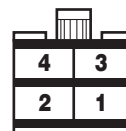

## How to Assemble the Cable with the Accessory Connector

Strip back the cable jacket approx. 3 mm {0.1"} and separate the individual conductors.

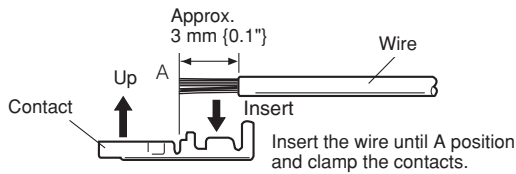

Prepare the individual conductors for clamping. Use MOLEX band tool part number 57027-5000 (for UL-Style Cable UL1015) or 57026-5000 (for UL-Style UL1007) for clamping the contacts.

After clamping the contacts, push them into the proper holes in the accessory connector of this camera until they snap in place.

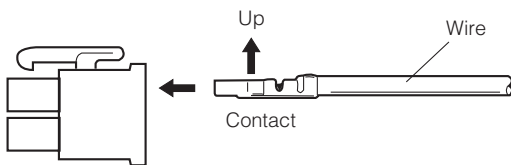

### Cautions:

- Shrinking the cable-entry seal is a one-time procedure. Do not shrink the cable-entry seal until ascertaining that the unit is functioning.
- CONNECT THIS TO 24 V AC CLASS 2 POWER SUPPLY ONLY.

# RS485 SETUP

Use the following procedure to configure the RS485 setup when you want to use the system controller to control the camera (pan, tilt, etc.) via the camera's data port.

1. Display the setup menu (page 21), move the cursor to COMMUNICATION "↓", and then press the CAM (SET) button.

This will display the RS485 setup menu.

2. Check the unit number. (page 13)

The UNIT NUMBER item shows the unit number specified by DIP Switch 1. The factory default unit number is 1.

If DIP Switch 1 specifies 1 to 96 as the unit number, move the cursor to UNIT NUMBER and then tilt the joystick left or right to select a unit number (1 to 96).

** RS485 SETUP **	
UNIT NUMBER	1
SUB ADDRESS	----
BAUD RATE	19200
DATA BIT	8
PARITY CHECK	NONE
STOP BIT	1
XON/XOFF	NOT USE
WAIT TIME	OFF
ALARM DATA	AUTO2
DELAY TIME	OFF
RET TOP	

**Note:** It is not necessary to configure the RS485 SET UP menu SUB ADDRESS setting.

3. Move the cursor to BAUD RATE, and then tilt the joystick left or right to select a baud rate setting.

Tilting the joystick cycles through the baud rate (transmission speed) display in the sequence shown below. (unit: bits/s) The factory default setting is 19200.

2400 ↔ 4800 ↔ 9600 ↔ 19200

4. Move the cursor to DATA BIT, and then tilt the joystick left or right to select a data bit setting (7 or 8).

The factory default setting is 8.

5. Move the cursor to PARITY CHECK, and then tilt the joystick left or right to select a parity bit setting (NONE, ODD, EVEN).

The factory default setting is NONE.

6. Move the cursor to STOP BIT, and then tilt the joystick left or right to select a stop bit setting (1 or 2).

The factory default setting is 1.

7. Move the cursor to XON/XOFF, and then tilt the joystick left or right to select an XON/XOFF setting.

The factory default setting is NOT USE.

**NOT USE:** Disables X ON/X OFF data flow control.

**USE** : Enables X ON/X OFF data flow control.

8. Move the cursor to WAIT TIME, and then tilt the joystick left or right to select a wait time setting.

The wait time is the time that the camera should wait before resending data when no receive acknowledgement (ACK) is returned after data is sent.

Tilting the joystick cycles through the wait time display in the sequence shown below. (unit: ms)

The factory default setting is OFF.

OFF ↔ 100MS ↔ 200MS ↔ 400MS ↔ 1000MS

9. Move the cursor to ALARM DATA, and then tilt the joystick left or right to select an alarm data send mode setting.

**POLLING** : Sends alarm data in response to a request by the system controller.

**AUTO1** : Sends alarm data each time an alarm signal is input.

**AUTO2** : Sends alarm data at five-second intervals. This is the factory default setting.

10. Move the cursor to DELAY TIME, and then tilt the joystick left or right to select a delay time setting.

The delay time is the time the camera should wait before sending a receive acknowledge (ACK). The delay time display changes in the sequence shown below. (unit: ms) The factory default setting is OFF.

OFF ↔ 100MS

This setting can be configured only when 2-line configuration is selected by DIP Switch 2. (page 12)

# USING THE SETUP MENU

For details about operations, see the operating instructions for the equipment you are using.

This manual describe procedures for operating system controller WV-CU650.

All setting configuration procedures start from the setup menu. This section explains how to display the setup menu and provides details about the menu items that it contains.

## ■ Displaying the Setup Menu

### ● When using the WV-CU650

- (1) Select the camera you want to set up (this camera), and the monitor where you want to display the setup menu.
- (2) Press the MENU button to display LCD MENU CAM 101.
- (3) Press the ENTER button or CAM (SET) button to display CAMERA SETUP.
- (4) Press the F1 button.

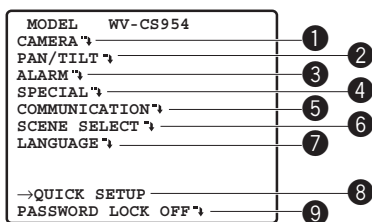

Refer to the pages below for details of setup menu items.

① CAMERA	Camera Settings	Page 22
② PAN/TILT	Pan and Tilt	Page 27
③ ALARM	Alarm Settings	Page 36
④ SPECIAL	Special Settings	Page 39
⑤ COMMUNICATION*	Communication Settings	Page 20
⑥ SCENE SELECT	Scene Select Settings	Page 40
⑦ LANGUAGE	Language Setting	This page
⑧ QUICK SETUP	Quick Menu Settings	Page 41
⑨ PASSWORD LOCK	Password Settings	Page 42

\* This item appears only when RS485 settings are configured with the DIP switches.

## ■ Language Setting

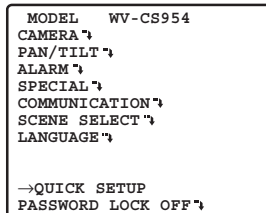

1. Move the cursor to LANGUAGE ↵, and then press the CAM (SET) button.
  2. On the 8-language selection menu that appears, select the language you want to use.
- \* All of the example screens in these Operating Instructions show English display messages.
3. Move the cursor to SET, and then press the CAM (SET) button.  
When you switch the languages, the password and titles are deleted.
- \* The item that was set flashes when the language is being changed and stops flashing when the language has been changed. Do not operate the system controller when changing settings.
- \* If you have selected either Japanese or Chinese as the language, only the IDs and titles can be set in katakana or Chinese.
- \* The "LANGUAGE" display remains in English even when the language setting is changed.

# CAMERA SETTINGS

## ■ Using the Camera Setup Menu

Display the camera setup menu from the setup menu to configure camera settings. First, display the camera setup menu.

1. Display the setup menu (page 21), move the cursor to CAMERA  $\downarrow$ , and then press the CAM (SET) button.

This will display the camera setup menu.

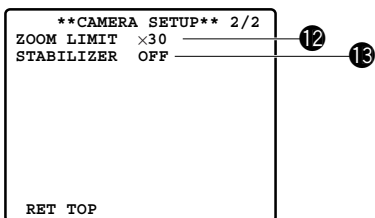
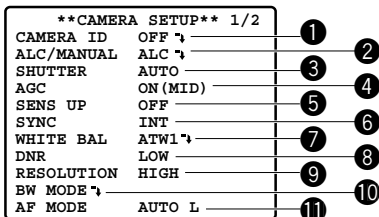

\* The following sections numbered ① to ⑬ explain how to use each of the camera setup menu items.

### (1) Camera ID (CAMERA ID)

The camera ID is a series of alphanumeric characters that indicate the location of the camera. This item can be used to turn display of the camera ID on the monitor screen on or off, and to input the camera ID.

1. Move the cursor to CAMERA ID, and then tilt the joystick left or right to toggle camera ID display on and off.
2. Select ON or OFF, and then press the CAM (SET) button.
3. Use the joystick to move the cursor the character you want to input, and then press the CAM (SET) button.

This will cause the selected character to appear in the camera ID input area. Repeat step 3 as many times as necessary to input all of the characters for the camera ID. (Example: DOOR)

#### To input a blank space

Move the cursor to SPACE, and then press the CAM (SET) button.

#### To delete all previously input characters

Move the cursor to RESET, and then press the CAM (SET) button.

#### To change previously input characters

Use the joystick to move the cursor to the camera ID input area. Next, tilt the joystick left and right to move the  $\uparrow$  pointer to the character you want to change. Finally, use step 3 above to input the new character.

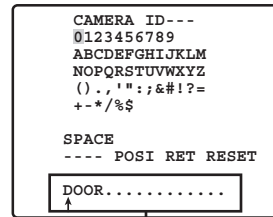

Camera ID Input area

4. Move the cursor to POSI, and then press the CAM (SET) button.  
This will display the ID position setting menu.
5. Use the joystick to select a camera ID display position, and then press the MON (ESC) button.  
This registers the camera ID display position and returns to the camera setting menu.

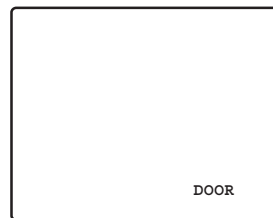

### (2) Light Control (ALC/MANUAL)

1. Move the cursor to ALC/MANUAL, and then tilt the joystick left or right to toggle between ALC and MANUAL.

**ALC** : Enables automatic lens iris adjustment in accordance with subject brightness. Select this ALC when using SUPER-D III.

**MANUAL**: Adjust the lens iris with the IRIS button on the system controller. Fixes the lens iris.

**Note**: The backlight compensation submenu associated with this menu is described separately and should be set up after installing the camera at the site and observing the actual site picture.

2. If ALC is set in step 1, press the CAM (SET) button to set SUPER-D III.

### SUPER-D III (Super Dynamic III)

When there is wide variation between the illumination of light and dark areas of the location being monitored, the camera adjusts the lens iris in accordance with the bright areas. This causes loss of detail in dark areas. Conversely, adjusting lens brightness for the dark areas cause brighter area to become washed out. SUPER-D III digitally combines an image that is set up for a clear view of bright areas with an image that is set up for a clear view of dark areas, creating a final image that preserves overall detail.

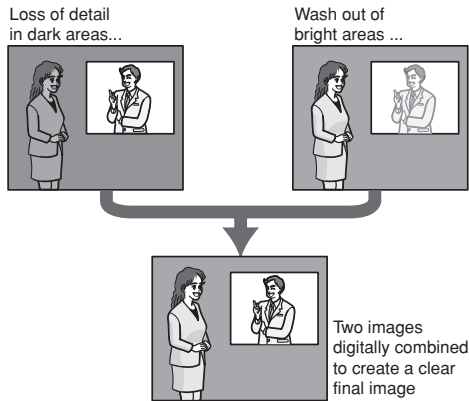

**Notes:**

- SUPER-D III is supported only when ALC is selected for light control (ALC/MANUAL).
- Camera settings are limited to the following when SUPER-D III is turned on.

**SHUTTER** : OFF, AUTO (This page)

**SENS UP** : OFF, AUTO (page 24)

- If lighting conditions cause either of the following phenomena, turn off SUPER-D III.
  - (1) Screen flickering or abnormal color
  - (2) Digital noise in the bright areas of the screen

3. Move the cursor to SUPER-D3, and then tilt the joystick left or right to toggle between on and off.

**ON** : Turns on SUPER-D III. (Go to Step 6)

**OFF** : Turns off SUPER-D III. (Go to Step 4)

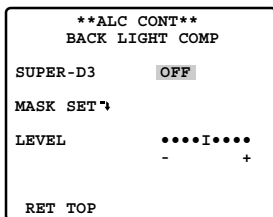

4. Move the cursor to MASK SET " $\wedge$ ", and then press the CAM (SET) button.

This will display the mask area screen, with the cursor in the upper left cell.

5. Mask the cells in the area where background lighting is bright. Masking an area will cause its brightness level to be ignored.

Use the following steps to perform masking

(1) Tilt the joystick up and down, and left and right to move the cursor to a cell you want to mask.

(2) Press the CAM (SET) button to mask the cell.

Moving the cursor to a cell that is already masked causes the blinking pattern of the cursor to alternate between horizontal stripes and white.

Pressing the CAM (SET) button while the cursor is located at a masked cell cancels the masking of the cell.

To cancel all masking areas, press the F2 button of WV-CU550C. For WV-RM70, press the right

and left switches simultaneously.

(3) After masking all of the cells you want, press the MON (ESC) button to return to the ALC CONT menu in step 1.

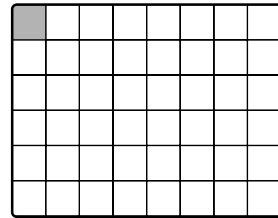

6. Move the cursor to LEVEL, and then tilt the joystick left and right to adjust the picture output level (picture contrast).

If you selected ON in step 3 of this procedure, best results can be obtained by setting a contrast level that is somewhat high. A contrast level that is too high, however, may increase the tendency of afterimages and noise.

**Note:**

- If operation of the system controller's IRIS (OPEN, CLOSE) button during operation is done after the menu is closed, the LEVEL on the CAMERA menu is reflected and stored for these settings. However, if the camera is in a preset position, it is reflected as a parameter of the preset position. To return to the initial factory default level, execute the system controller's iris reset.
- When the Light Control is in ALC, "IRIS-CLOSE" is displayed below the pan/tilt/zoom position display when the iris is completely closed. When the Light Control is in MANUAL, "IRIS-CLOSE" is not displayed.

**(3) Shutter Speed (SHUTTER)**

1. Move the cursor to SHUTTER, and then tilt the joystick left or right to select a shutter speed setting.

Tilting the joystick cycles through the shutter speed settings display in the sequence shown below. (unit: sec)

**When SUPER-D III is turned off**

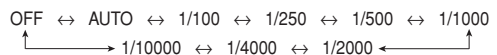

**When SUPER-D III is turned on**

OFF ↔ AUTO

**AUTO:** This setting, by moving the shutter automatically when necessary, provides a clearer picture of extremely bright objects outdoors, etc.

**OFF** : Fixed at 1/60 seconds.

#### Notes:

- When AUTO is selected for the shutter setting, fluorescent lighting may cause flickering of the picture. If this happens, select OFF or 1/100 for the shutter speed setting.
- AUTO is disabled when MANUAL is selected for light control (ALC/MANUAL) and FIX is selected for electronic sensitivity enhancement (SENS UP).

#### (4) Gain Control (AGC)

1. Move the cursor to AGC, and then tilt the joystick left or right to select a gain control setting.

**ON (LOW)** : Low gain

**ON (MID)** : Medium gain

**ON (HIGH)** : High gain

**OFF** : Fixed gain

**Note:** When AGC is turned on, the noise reduction function automatically activates under low illumination to reduce digital noise. This also, however, can cause afterimages to be generated by moving objects, and by panning and tilting the camera. For more information, see the DNR setting (page 25).

#### (5) Electronic Sensitivity Enhancement (SENS UP)

1. Move the cursor to SENS UP, and then tilt the joystick left or right to select an electronic sensitivity enhancement setting.

The electronic sensitivity enhancement setting can be changed only when OFF or AUTO is selected for the shutter speed (SHUTTER) setting. Tilting the joystick cycles through the settings display in the sequence shown below.

##### When SUPER-D III is turned off

```

OFF ↔ X2 AUTO ↔ X4 AUTO ↔ X6 AUTO ↔ X10 AUTO ↔ X16 AUTO
  ↓                                     ↓
X32 FIX                               X32 AUTO
  ↓                                     ↓
X16 FIX ↔ X10 FIX ↔ X6 FIX ↔ X4 FIX ↔ X2 FIX ↔ OFF

```

##### When SUPER-D III is turned on

```

OFF ↔ X2 AUTO ↔ X4 AUTO ↔ X6 AUTO
↙ X32 AUTO ↔ X16 AUTO ↔ X10 AUTO ↘

```

**Note:** The following are the differences between AUTO and FIX.

**AUTO:** Selecting X32 AUTO, for example, automatically increases sensitivity, up to a maximum of 32 times.

**FIX** : Selecting X32 FIX, for example, increases sensitivity 32 times.

The FIX settings cannot be selected when the shutter speed (SHUTTER) setting is 1/100.

**Caution:** Turning on SENS UP can cause digital noise and white spots (blemish) to appear in the picture.

#### (6) Synchronization (SYNC)

This camera supports the following three sync modes, which are listed in priority sequence from highest priority to lowest.

- (1) Multiplexed vertical drive (VD2)
- (2) Internal sync (INT)
- (3) Line-lock (LL)

Input of a multiplexed vertical driver (VD2) signal automatically switches to VD2 sync, regardless of the camera's current sync mode (SYNC). In this case, the camera setting menu shows EXT (VD2) for the SYNC setting, which cannot be changed to internal sync (INT) or line-lock (LL).

The following procedures explain how to select internal sync (INT) and line-lock sync (LL), and how to perform phase adjustment when line-lock sync (LL) is selected.

1. Move the cursor to SYNC, and then tilt the joystick left or right to select the sync mode.

**INT** : Internal sync

**LL** : Line-lock (Cannot be used in areas with 50 Hz power.)

Selecting LL and pressing the CAM (SET) button will display the SYNC setting menu, which can be used for configuring detailed settings. (This page)

#### ● Adjusting the Phase for Line-lock Synchronization

Connect the video output signal of the camera being adjusted and the reference video output signal to a two-input oscilloscope.

Set the oscilloscope to the vertical rate, and then expand the vertical sync portion on the oscilloscope.

1. Move the cursor to COARSE, and then tilt the joystick left or right to align the coarse adjustment of the vertical phases of the camera being adjusted with that of the reference camera.

Coarse adjustment be performed across 16 steps (1 through 16). Adjusting past step 16 returns to step 1.

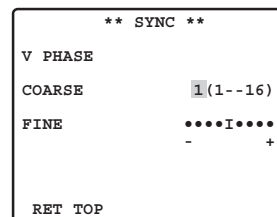

2. Move the cursor to FINE, and then tilt the joystick left or right to align the fine adjustment of the vertical phases of the camera being adjusted with that of the reference camera.

#### Notes:

- To reset COARSE and FINE to the preset values, press the F3 button. For WV-RM70, press the right and left switches simultaneously. COARSE is preset to zero-crossing of the AC line phase.
- If the AC line phase contains spike noise, etc., the vertical phase of the video output signal may be disturbed.



## (7) White Balance (WHITE BAL)

1. Move the cursor to WHITE BAL, and then tilt the joystick left or right to select a white balance mode.

### (1) Auto-Tracing White Balance Mode (ATW1/ATW2)

In this mode, the camera continually monitors the color temperature of the light source and automatically adjusts white balance.

The following are the approximate supported color temperature ranges in this mode.

**ATW1:** 2,700 K to 6,000 K

**ATW2:** 2,000 K to 6,000 K (Mode recommended for sodium lighting)

Proper white balance may not be possible under the following conditions. In such cases, use the AWC while balance mode.

- When the subject contains mostly dark colors
- When the light source is a deep blue sky or twilight
- When illumination of the subject is low

### (2) Auto-Tracing White Balance Control (AWC)

In this mode, the supported color temperature range is approximately 2,000 K to 10,000 K. This mode is best in locations where the light source is constant.

- (a) To select AWC, tilt the joystick left and select AWC→PUSH SET.

- (b) Press the CAM (SET) button to start white balance adjustment. PUSH SET is highlighted on the display while white balance adjustment is being performed.

- PUSH SET becomes unhighlighted again when white balance adjustment is complete. Tilt the joystick right to display AWC.
- If white balance adjustment cannot be completed for some reason, PUSH SET will remain highlighted on the display. If this happens, it could mean that the color temperature is outside the supported range, or that illumination is too low.

2. Select ATW1, ATW2, and AWC, then press the CAM (SET) button, either the ATW setting menu or the AWC setting menu appears, and you can fine tune the white balance.

Move the cursor to R or B, and then tilt the joystick left or right to fine tune the level. The R is red and the B is blue, moving in the + direction makes the colors darker, moving in the - direction makes them lighter.

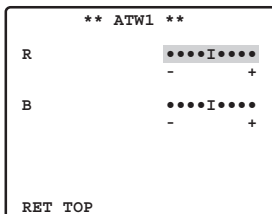

**Note:** White balance is adjusted in accordance with on-screen color temperature, which the camera detects automatically. Correct adjustment may not be possible if a strong light source is shining on the screen.

## (8) Digital Noise Reduction (DNR)

1. Move the cursor to DNR, and then tilt the joystick left or right to select a digital noise reduction (DNR) setting.

**LOW** : Low DNR, Low afterimage

**HIGH** : High DNR, High afterimage

## (9) Resolution (RESOLUTION)

1. Move the cursor to RESOLUTION, and then tilt the joystick left or right to select NORMAL or HIGH.

**NORMAL** : Sets horizontal resolution to a minimum of 480 lines. (In color mode)

**HIGH** : Sets horizontal resolution to a minimum of 520 lines. (In color mode)

## (10) Black and White Mode (BW MODE)

Moving the cursor to BW MODE and pressing the CAM (SET) button displays a BW MODE setting menu.

Use the BW MODE setting menu to configure black and white mode settings.

1. Move the cursor to BW, and then tilt the joystick left or right to select a black and white control setting.

**AUTO** : The camera automatically switches between the color mode and the black and white mode in accordance with picture brightness (illuminance).

The black and white mode is selected when lighting is low, while the color mode is selected for bright lighting.

**ON** : Selects the black and white mode.

**OFF** : Selects the color mode.

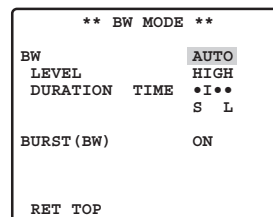

**Note:** The above setting cannot be configured when BW is selected for the ALARM IN 4 setting (page 38).

2. If you selected AUTO in step 1, move the cursor to LEVEL and then tilt the joystick left to select the threshold illuminance level for switching between the color mode and the black and white mode.

The illuminance shown below is based on the assumption that the camera is used in an area lit by halogen lamps, and that AGC on the menu is set to MID.

**LOW** : Switches to the black and white mode when illuminance around the camera is approximately 1.5 lux{fc} or lower (when AGC ON (MID), SENS UP OFF is set).

**HIGH** : Switches to the black and white mode when illuminance around the camera is approximately 3 lux{fc} or lower (when AGC ON (MID), SENS UP OFF is set).

**Note:** When near-infrared lamps are used, the image may be displayed out of focus and mode switching may not perform automatically.

3. If you selected AUTO in step 1, move the cursor to DURATION TIME and then tilt the joystick left to select the time the camera should wait before switching between the color mode and the black and white mode after there is a change in the illuminance level.

**Available Settings:** 10 s - 30 s - 60 s - 300 s  
(S) (L)

**Note:** When AUTO is selected, switching between the color mode and the black and white mode is not performed while pan, tilt, zoom, or focus is being performed.

4. Move the cursor to BURST (BW), and then tilt the joystick left or right to turn burst signal output on or off.

This setting is for black and white mode display.

**ON:** Turns on burst signal output.

**OFF:** Turns off burst signal output.

**Note:** With some monitors and VCR models, output of a camera images in the black and white mode will not display a proper image unless a burst signal is provided. Select ON for this setting when using equipment that requires a burst signal.

#### (11) Auto Focus (AF MODE)

1. Move the cursor to AF MODE, and then tilt the joystick left or right to select an auto-focus mode setting.

**MANUAL S.M.L :** Activates auto-focus when the AF button on the system controller is pressed.

**AUTO S.M.L :** Auto focus is used automatically when PAN, TILT or ZOOM are used in manual operation.

The letters S (Small), M (Medium), and L (Large) indicate the size of the auto-focus sensing area.

#### Notes:

- The AUTO (S.M.L.) setting can be selected only when OFF, x2 FIX or x2 AUTO is selected for the electronic sensitivity enhancement (SENS UP). Any other SENS UP setting causes MANUAL (S.M.L.) to be selected automatically for the auto-focus mode (AUTO AF).
- Zooming up from WIDE can cause the image to go out of focus.
- Auto-focus may not be possible with the types of objects listed below. For such objects, focus manually.

#### Example:

- Shiny or high intensity objects
- Objects shot through wet or dirty glass

- Pictures that are a mixture of distant and nearby objects
- White walls and other single-color objects
- Venetian blinds and other vertically striped objects
- Slanted objects
- Objects illuminated with low lighting

Auto-focus focuses on the object in the center of the picture, so objects around the outside periphery of the picture will not be in focus.

#### (12) Zoom Limit (ZOOM LIMIT)

1. Move the cursor to ZOOM LIMIT, and then tilt the joystick left or right to select a zoom limit setting.

When doing manual operation, zoom operation cannot go beyond the zoom limit.

Optical zoom ranges from 1 to 30 magnifications, while digital zoom is used for higher magnifications (up to 300).

#### Notes:

- If zoom limit is set to more than 30x, then zoom operation pauses at 30x magnification.
- Increasing the zoom to over 30x magnification (digital zoom) decreases the resolution.
- You cannot set a zoom magnification of greater than 30x as a preset position.

#### (13) Auto Image Stabilizer (STABILIZER)

This function electronically compensates for an unstable camera image due to movement of a mounting pole or bracket.

1. Move the cursor to STABILIZER, and then tilt the joystick left or right to turn the stabilizer on or off. The default setting is OFF

**ON :** Automatically compensates for an unstable image.

**OFF :** Image stabilizer will not operate.

#### Notes:

- The stabilizer may not be effective for the following subjects.
  - Example: • Objects illuminated with low lighting
    - Single-color objects (white walls etc)
- Fast moving periodic action, such as mechanical vibration, may not be tracked.
- The stabilizer does not work during PAN/TILT/ZOOM/FOCUS or when the camera setup menu is open.
- When set to ON, some effective pixels on the edge of the CCD are used by the stabilization function. This may result in a small reduction in resolution and a narrower angle of view. After activating the image stabilizer function, check that the field of view is correct.
- Image stabilization may not function where there is excessive camera movement or when the scene is low light or low contrast objects.

## ■ Using the Pan/Tilt Setup Menu

Display the pan/tilt setup menu from the setup menu to configure pan and tilt settings.

First, display the pan/tilt setup menu.

Use a shortcut (page 45) to switch between displaying or not displaying the pan, tilt, and zoom positions (during pan, tilt and zoom operation) on the monitor screen.

\* The tilt position is displayed ranging from -5° to 90° to -5°.

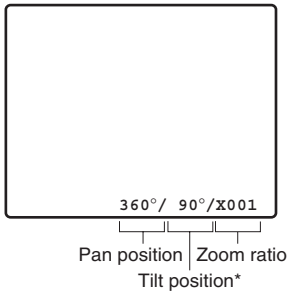

1. Display the setup menu (page 21), move the cursor to PAN/TILT **↵**, and then press the CAM (SET) button. This will display the pan/tilt setup menu.

**PAN/TILT SETUP**1/2	
PRESET 1*	1
MAP ↵	2
HOME POSITION OFF	3
SELF RETURN OFF	4
AUTO MODE OFF	5
AUTOPAN KEY AUTO PAN	6
PATROL ↵	7
PRIVACY ZONE OFF	8
IMAGE HOLD OFF	9
DIGITAL FLIP ON	10
PROPO. P/T ON	11

**PAN/TILT SETUP**2/2	
AREA TITLE ON (USER) ↵	12
TILT ANGLE 0°	13
CLEANING OFF	14
RET TOP	

\* The following sections numbered ① to ⑭ explain how to use each of the pan/tilt setup menu items.

### (1) Position Number Selection (PRESET)

Positions can be assigned numbers, each of which can be configured with a monitoring position and monitoring conditions.

You can use either the PRESET item or the MAP item on the pan/tilt setup menu to select a position number.

Position numbers 1 through 4 are used for alarm functions (pages 37 and 38) and operating them.

1. Move the cursor to the 1 next to the PRESET item, and then tilt the joystick left or right to change the position number to the one you want.
2. Press the CAM (SET) button.

This registers the position number setting and displays the preset setting menu. (this page)

### (2) Position Number Selection (MAP)

You could use the MAP item on the pan/tilt setup menu instead of the PRESET item to select a position number.

1. Move the cursor to MAP **↵**, and then press the CAM (SET) button.

**PRESET POSITION**			
1*	2	3	4
5	6	7	8
9	10	11	12
13	14	15	16
17	18	19	20
21	22	23	24
25	26	27	28
29	30	31	32
ID: DOOR			
033-064 225-256			
RET TOP			

2. Move the cursor to the number you want to select, and then press the CAM (SET) button.

This registers the position number setting and displays the preset setting menu. (this page)

To select a position number in the range of 033 to 064, move the cursor to 33-64 in the lower left corner of the menu, and then press the CAM (SET) button.

Preset numbers set subsequently are the same.

**PRESET POSITION**			
33	34	35	36
37	38	39	40
41	42	43	44
45	46	47	48
49	50	51	52
53	54	55	56
57	58	59	60
61	62	63	64
ID:			
065-096 001-032			
RET TOP			

### Notes:

- An asterisk (\*) to the right of a position number indicates that it already has a preset position assigned to it.
- The home position number is indicated by the letter H next to the asterisk.
- When the cursor is located at a position number that has a position ID, the position ID text appears next to ID: on the menu screen.

## ● Position Setting (POSITION SET)

The position setting can be used to specify the camera position (pan and tilt), the lens zoom setting, and the focus setting.

1. Move the cursor to POSITION SET **↵** and press the CAM (SET) button to display the position setting menu.

PRESET NO. 1*	
POSITION SET ↵	
PRESET ID ON ↵	
ALC/MANUAL ALC ↵	
AF MODE MANUAL L	
DWELL TIME 10S	
SCENE FILE OFF	
PRESET SPEED	••••••••I
	L H
RET TOP DEL	

2. Move the cursor to →PUSH SET to the right of PAN/TILT, and then press the CAM (SET) button to display the PAN/TILT setting menu.

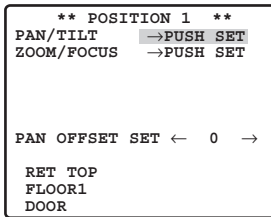

- Use the joystick to position the camera, and then press the CAM (SET) button.

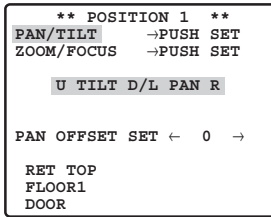

- Move the cursor to → PUSH SET to the right of ZOOM/FOCUS, and then press the CAM (SET) button to display the ZOOM/FOCUS setting menu.

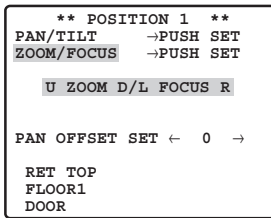

- Move the joystick left, right, up and down to adjust the position of the lens focus, and then press the CAM (SET) button.

**Notes:**

- Focusing may be difficult when the camera is at an angle that is close to horizontal.
- A different position number can be selected by moving the cursor to the position number at the top of the position setting menu and tilting the joystick left and right. Pressing the CAM (SET) button will change to the setting screen for the newly selected position number.
- The currently registered camera ID and preset ID appear at the bottom of the position setting menu.
- When using a system device other than the WV-CU650/CU950\*, WJ-HD309A/HD316A over 65 position numbers cannot be set. (as of February 2005)

\* Operation procedure may vary depending on the version of the system controller's software.  
 For Ver.1.xx or earlier: only camera function operations are supported  
 For Ver.2.xx or later: PRESET/PGM PRESET button is also supported

Align the cursor here

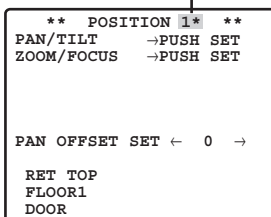

## ● Adjusting Camera Position When Changing Cameras (PAN OFFSET SET)

The system controller etc. has a function for downloading (saving) and uploading (recovering) setting information for the camera. This function allows you to upload (recover) original setting information that has been downloaded (saved) before some unforeseen damage or malfunction causes setting information in the camera to be lost. However, there may be some slight differences in images from those uploaded (recovered) when the camera is changed. The "PAN OFFSET SET" function is for adjusting these differences.

- Align the cursor with "PAN OFFSET SET" with the ← or → arrow, and press the CAM (SET) button to set the offset value.

Set the offset value to 0.0, or in a range of -10 to +10. All preset positions for the camera's position are adjusted according to the offset value.

**Important:** Data is not compatible with existing cameras. Uploading setting information from existing cameras will damage data in the camera. If data in the camera is damaged, download camera setting information from a camera that still has the factory settings and then upload it to the camera with the damaged data.

## ● Preset ID Setting (PRESET ID)

The preset ID is a series of alphanumeric characters that indicate the location of the camera. This item can be used to turn display of the preset ID on the monitor screen on or off, and to input the preset ID.

- Move the cursor to PRESET ID, and then tilt the joystick left or right to toggle preset ID display on and off.

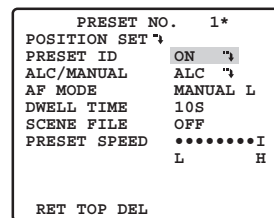

- Select ON or OFF, and then press the CAM (SET) button.

This will display the preset ID setting menu.

- Use the joystick to move the cursor the character you want to input, and then press the CAM (SET) button. The text input procedure is the same as that for camera ID input.

See steps 3 through 5 under "(1) Camera ID (CAMERA ID)" on page 22 for information about inputting the text for the preset ID and specifying its position on the display.

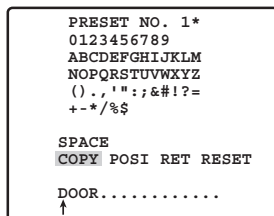

**To copy the preset ID of another position number**  
 Move the cursor to COPY, and then press the CAM (SET) button. This displays the preset ID of the position number preceding the one you are currently configuring. Each press of the CAM (SET) button scrolls back to the next sequential position number and displays its preset ID.

## ● Light Control (ALC/MANUAL)

See page 22 and 23 for information on the setting method. You can adjust the lens iris setting on the detailed menu when MANUAL is set.

## ● Auto Focus (AF MODE)

1. Move the cursor to AF MODE, and then tilt the joystick left or right to select an auto-focus function setting.  
**MANUAL S.M.L** : Auto focus does not operate after moving to a preset position.  
**AUTO S.M.L** : Auto focus operates after moving to a preset position.

## ● Sequence/Sort DWELL Time (DWELL TIME)

This section explains how to set the length of time the camera stops (time it stops rotating) and tapes the scene while in the various preset positions for the sequence and sort operations (page 30).

1. Move the cursor to DWELL TIME, and then tilt the joystick left or right to select a DWELL time setting. Tilting the joystick cycles through the stop time display in the sequence shown below. (unit: sec, min)

2S ↔ 3S ↔ 5S ↔ 10S ↔ 30S ↔ 1MIN  
 ↑                      ↓  
 →4MIN ↔ 3MIN ↔ 2MIN←

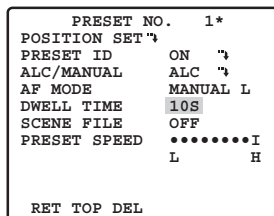

## ● Scene File Setting (SCENE FILE)

Up to 10 scene files, each of which contains camera settings for a specific location (scene), can be stored in memory. Scene files are managed using scene file numbers from 1 through 10, and can be selected when configuring preset position settings.

The following procedures explain how to select a scene file and how to configure scene file settings.

- (1) Selecting a Scene File  
 Use this procedure when you want to apply the settings of a previously stored scene file when you are configuring the settings of a preset position.

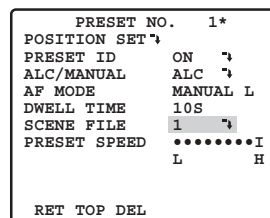

1. Move the cursor to SCENE FILE, and then tilt it left and right to select the number of the scene file you want to select.
- (2) Configuring Scene File Settings  
 1. Move the cursor to SCENE FILE, and then tilt it left and right to select the number of the scene file whose settings you want to configure.

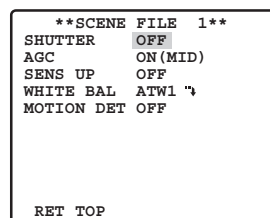

2. Press the CAM (SET) button.  
 This will display the scene file setting menu.  
 The following items can be set on the Scene file settings menu. See camera settings for details on each setting.
  - SHUTTER (page 23, 24)
  - AGC (page 24)
  - SENS UP (page 24)
  - WHITE BAL (page 25)
  - MOTION DET (page 36)

## ● Preset Speed Setting (PRESET SPEED)

Set the speed the camera moves to the various preset positions for the sequence and sort operations (page 30).

1. Move the cursor to PRESET SPEED, and then tilt the joystick left or right to change the speed setting. Shifting the setting towards the L side decreases the speed, while shifting towards the H side increase it.

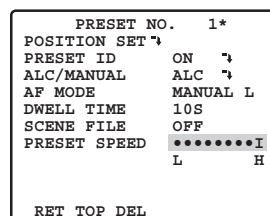

## ● Deleting a Preset Position (DEL)

1. Move the cursor to DEL, and then press the CAM (SET) button.

This deletes the contents of the currently selected position number and displays the position selection menu.

```

PRESET NO.      1*
POSITION SET   ↵
PRESET ID      ON  ↵
ALC/MANUAL    ALC  ↵
AF MODE       MANUAL L
DWELL TIME    10S
SCENE FILE    OFF
PRESET SPEED  *****I
                L      H

RET TOP DEL
    
```

```

**PRESET POSITION**
 1*   2*   3*   4*
 5*   6*   7*   8*
 9*  10*  11*  12*
13*  14*  15*  16*
17*  18*  19*  20*
21*  22*  23*  24*
25*  26*  27*  28*
29*  30*  31*  32*
ID:DOOR
033-064 225-256
RET TOP
    
```

### (3) Home Position Setting (HOME POSITION)

A currently configured preset position can be designated as the home position.

Pressing the HOME button of the system controller will cause the camera to move to the currently specified home position. Use the following procedure to make a preset position the home position.

1. Move the cursor to HOME POSITION, and then tilt the joystick left or right to select the position number of the preset position you want to make the home position.

This causes the preset position whose position number you select to become the home position. If you do not want to use the home position function, select OFF for the HOME POSITION setting.

### (4) Self Return Setting (SELF RETURN)

The self return setting can be used to specify automatic return to a particular mode if a certain amount of time elapses without any operation being performed.

1. Move the cursor to SELF RETURN, and then tilt the joystick left or right to select a self return trigger setting. Tilting the joystick cycles through the self return display in the sequence shown below. (unit: sec, min)

```

OFF ↔ 1S ↔ 2S ↔ 3S ↔ ..... ↔ 10S ↔ 20S ↔ 30S ↔ 40S
  ↓
60MIN                               50S
  ↓
30MIN ↔ 20MIN ↔ 10MIN ↔ 5MIN ↔ 3MIN ↔ 2MIN ↔ 1MIN
    
```

2. If you selected any setting other than OFF in step 1, press the CAM (SET) button and then tilt the joystick left or right to select a self return mode.

```

OFF ↔ AUTO ↔ HOME ↔ APAN ↔ SEQ ↔ SORT
  ↓
  ↓ TRK ↔ PTR4 ↔ PTR3 ↔ PTR2 ↔ PTR1 ↵
    
```

**OFF** : In the auto mode, exits the auto mode when the trigger time elapses.

**AUTO (AUTO MODE setting not OFF)** : Returns to the auto mode when the trigger time elapses.

**AUTO (AUTO MODE setting OFF)** : Returns to the home position when the trigger time elapses.

**HOME** : Returns to the home position when the trigger time elapses.

**APAN** : Activates auto pan when the trigger time elapses.

**SEQ** : Activates the sequence function when the trigger time elapses.

**SORT** : Activates the sort function when the trigger time elapses.

**PTR 1 to 4** : Activates the patrol function when the trigger time elapses.

**TRK** : After the trigger time elapses, the camera returns to the home position and then automatic tracking starts. Following that, after a set time, the camera returns to the home position and starts to continue automatic tracking.

#### Notes:

- The HOME setting should be selected when you want to normally leave the camera in the home position and occasionally perform pan and tilt, or when you want to activate SEQ.
- PATR1-4 displays only the set number of patrol routines (page 32).

### (5) Auto Mode Setting (AUTO MODE)

Use the auto mode setting to specify the camera movement mode (OFF, SEQ, SORT, AUTO PAN, PATROL 1~4, AUTO TRACK).

After selecting AUTO PAN, you can use the AUTO PAN setting menu to configure detailed settings.

1. Move the cursor to AUTO MODE, and then tilt the joystick left or right to select a camera movement mode setting.

**OFF** : Manual movement only

**SEQ** : Sequentially switches between preset positions in position number sequence. (sequential movement)

**SORT** : Sequentially switches between preset positions counterclockwise, starting from the camera home position. (sort movement)

**AUTO PAN**: Camera pans automatically within the range specified by PAN. Selecting AUTO PAN and pressing the CAM (SET) button will display the AUTO PAN setting menu, which can be used for configuring detailed settings. (page 31)

**PATROL 1 to 4**: Operates the camera in accordance with patrol function settings.

**AUTO TRACK**: Auto tracking is done for moving objects under the following conditions.

The moving object must be larger than one of the screen blocks (1/48 of screen area), it must have 5 % comparative contrast with the background image.

**Notes:**

- Automatic tracking covers a range from horizontal to directly below the camera. The digital flip function (page 34) does not operate. Also, the pan range can be limited by using the PAN LIMIT setting (this page). The automatic tracking function incorporated in this system easily tracks moving objects on screen. Moving subjects are not automatically tracked in the following situations.
- When multiple moving subjects are on screen
- When the subjects are moving very fast
- When the subject has little contrast
- When moving objects are either large or small
- When the image is dark
- When the image flickers

Tilting the joystick cycles through settings in the sequence shown below.

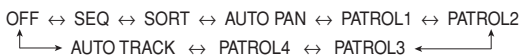

**Notes:**

- The auto mode is exited automatically whenever manual PAN/TILT or ZOOM/FOCUS is performed if AUTO PAN is operating and PAN/TILT does SEQ, SORT, PATROL, or AUTO TRACK movement. Note, however, that that the contents of the setting menu do not change. To return to the auto mode, open the setup menu and then close it again. The auto mode will also activate when the self return trigger time (page 30) elapses.
- During operation, the lens may enter the refresh mode.
- PATROL1-4 displays only the set number of patrol routines (page 32).

**● Configuring AUTO PAN Detailed Settings**

1. Perform the following steps to set the PAN start point and end point.
  - (1) Move the cursor to POSITION, press the CAM (SET) button, and then move the cursor to START.
  - (2) Use the joystick to move the camera to the desired PAN start point, and then press the CAM (SET) button. This defines the start point and moves the cursor to END.
  - (3) Use the joystick to move the camera to the desired PAN end point, and then press the CAM (SET) button. This defines the start point and moves the cursor to POSITION.

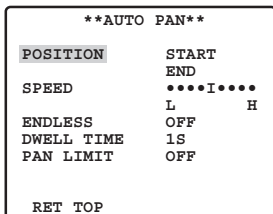

2. Move the cursor to SPEED and then tilt the joystick left or right to select a panning speed setting. Shifting the setting towards the "H" (right) side increases the speed, while shifting towards the "L" (left) side decreases it.
3. Move the cursor to ENDLESS, and then tilt the joystick left or right to turn endless panning on or off.
  - ON** :Pans from the start point to the end point, and then continues to pan in the same direction from the end point to the start point. Select OFF for the PAN LIMIT setting (step 5) when using this setting. Panning will be repeated endlessly.
  - OFF** :Pans from the start point to the end point, and then reverses direction to pan from the end point to the start point. Panning is repeated endlessly.

4. Move the cursor to DWELL TIME, and then tilt the joystick left or right to select the start point and end point dwell time setting. Tilting the joystick cycles through the stop time display in the sequence shown below. (unit: sec)

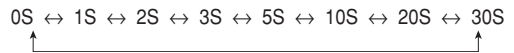

5. Move the cursor to PAN LIMIT, and then tilt the joystick left or right to toggle it on and off.
  - ON** :Limits manual panning to the zone between the start point and the end point. The TILT range is from horizontal to straight down. Select OFF for the ENDLESS setting (step 3) when using this setting.
  - OFF** :Allows manual panning outside the zone between the start point and the end point.

**PAN LIMIT**

PAN LIMIT allows panning in the area from the start point to the end point specified in step 1, but not in the area from the end point to the start point.

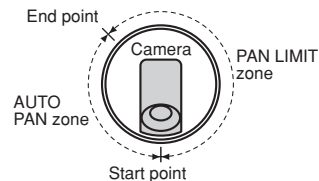

**Notes:**

- When the panning, tilting, zooming or focusing in the SEQ, SORT or PATROL mode is controlled manually, the auto mode function should be cancelled. To activate the auto mode, select the desired auto mode again or set a time for SELF RETURN in the SET UP menu.
- When 0S is selected, the camera stops without dwelling and starts.
- Auto refreshing may be activated during the patrol play or the auto mode to calibrate the lens position.

## (6) AUTO PAN Key Setting (AUTO PAN KEY)

Set the operations of the camera when AUTO PAN is executed from the system controller (page 30).

1. Move the cursor to AUTO PAN KEY, and then tilt the joystick left or right to select a camera movement mode setting.

Tilting the joystick cycles through settings in the sequence shown below.

AUTO PAN ↔ SEQ ↔ SORT ↔ PATROL1 ↔ PATROL2  
 ↑                      ↓  
 ← AUTO TRACK ↔ PATROL4 ↔ PATROL3 →

### Notes:

- Auto Mode can be started, but not stopped, with the AUTO PAN key.
- PATROL1-4 displays only the set number of patrol routines (page 32).

## (7) Patrol Function Setting (PATROL)

The patrol function remembers manual operations for later automatic playback when they are needed.

1. Aim the camera, with the menu closed, at the start point of the routine you want it to remember.
2. Move the cursor to NUMBER, and then tilt the joystick left or right to specify the number of patrol routines.

Tilting the joystick cycles through settings in the sequence shown below. The amount of storage time available depends on the number of routines. The storage time display changes in the sequence shown below. (unit: sec, min)

1(2MIN) ↔ 2(1MIN) ↔ 4(30S)

Note that the total patrol time is two minutes, and the time allowed for each routine depends on the number of patrol routines that are configured. The values in parentheses indicate the time of each patrol routine (two minutes for one pattern, one minute each for two patterns, 30 seconds each for four patterns).

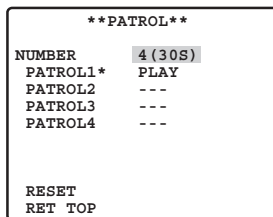

If you want to change the number of patrol routines from a previous setting, first delete all of the currently store patrol routines. To delete everything, move the cursor to RESET, and press the CAM (SET) button.

3. Move the cursor to a PATROL number (PATROL 1 through 4), and then tilt the joystick left or right to select a patrol setting.

--- : Disables the selected patrol routine.

**PLAY** : Performs the selected patrol routine. (see this page)

**LEARN** : Select this option to teach the camera a series of movements (patrol routine). (An asterisk (\*) to the right of a PATROL number indicates that it already has a patrol routine assigned to it.) (see this page)

**DEL→PUSH SET** : Press the CAM (SET) button to delete an existing patrol routine.

## <When PLAY is selected>

- (1) Press the system controller's F2 button to close the menu. The orientation of the camera moves to the stored start position, and the camera starts to playback the stored movement.
- (2) When the playback is finished, manually pan, tilt, zoom and focus.

## <When LEARN is selected>

- (1) Press the system controller's F2 button to close the menu. The start position is stored, and the camera's movements can be stored.
- (2) Operate the camera to store the movements. "LEARNING (\*\*S)" is displayed in the center of the screen when the movements are being stored. (unit: sec)  
 \* "(\*\*S)" indicates the amount of time that remains for storing movements.
- (3) The setup menu is displayed and teaching stops. Storing movements stops when the remaining time reaches "0S".

### Notes:

- Selecting LEARN to teach the camera a patrol routine causes the following parameters to be stored along with the camera movements.

- (1) Parameters at the Beginning of the Routine
  - PAN, TILT, ZOOM, and FOCUS positions
  - IRIS level
  - Shutter speed (SHUTTER)
  - Gain (AGC) setting
  - Electronic sensitivity enhancement (SENS UP) setting
  - White balance (WHITE BAL) setting
  - IMAGE HOLD
  - AREA TITLE
  - DIGITAL FLIP
  - PRIVACY ZONE
  - CAMERA ID
  - PROPO.PT
  - PAN LIMIT
  - ZOOM LIMIT
  - TILT ANGLE
  - BURST
  - CLEANING
- (2) During Camera Movement
  - PAN, TILT, ZOOM, and FOCUS positions
  - IRIS operation
  - Preset positioning

- In the patrol play mode, the camera movement may occasionally deviate from the entered routine when the routine includes a move to a preset position. If this happens, re-enter the routine of manual operations for patrol-learn.
- In the patrol play mode, black and white automatic switching does not work.
- In the patrol play mode, when the power of the system controller is turned on or off, the patrol play stops. In this case, press the PATROL PLAY button again. (If SELF RETURN is set to ON, the patrol play will start again after elapsing the setting return time.)



- Patrol movement covers a range from horizontal to directly below the camera. The digital flip function (page 34) does not operate.

### (8) Privacy Zone Setting (PRIVACY ZONE)

The privacy zone function makes it possible to mask specific areas of the scene (screen) from view. Up to eight privacy zones can be configured.

#### Notes:

- Certain camera orientations can cause privacy zone masked area to become visible.
  - The privacy zone function does not mask scene areas during the initialization routine performed immediately after camera power is turned on.
  - The zone position may shift if the stabilizer settings are change after setting the privacy zone.
1. Move the cursor to PRIVACY ZONE, and then tilt the joystick left or right to select a privacy zone setting.  
**ON (1)** : Turns on the privacy zone function.  
**ON (2)** : Turns on the privacy zone function. (Mosaic)  
**OFF** : Turns off the privacy zone function.  
 Use the following steps to configure privacy zones.
  2. Move the cursor to PRIVACY ZONE, and then press the CAM (SET) button.  
 This will display the ZONE NUMBER selection menu. The picture will be full wide angle (WIDE) if there is no privacy zone defined for the current zone number.

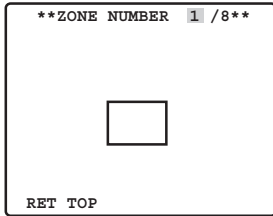

3. Move the cursor to ZONE NUMBER, and then tilt the joystick left or right to select the zone number (1 to 8) you want to configure.  
 An asterisk (\*) to the right of the a number indicates that it already has a privacy zone configured for it. Selecting such a zone number zooms the picture to the zoom setting that was in effect when its privacy zone settings were configured.
4. Press the CAM (SET) button.  
 This will display the zone setting menu. The appearance of the menu depends on zone settings.

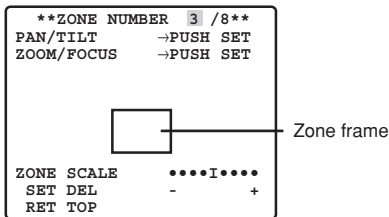

The currently configured zone frame will appear in the center of the picture.  
 Performing the remaining steps of this procedure will delete the current zone frame and replace it with the new zone frame that you configure.

5. Move the cursor to →PUSH SET to the right of PAN/TILT, and then press the CAM (SET) button.  
 This will display the PAN/TILT setting menu.
6. Use the joystick to point the camera at the location to be masked, and then press the CAM (SET) button.  
 This registers the camera position and returns to the zone setting menu.

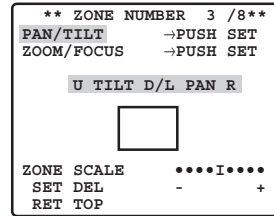

7. Move the cursor to →PUSH SET to the right of ZOOM/FOCUS, and then press the CAM (SET) button.  
 This will display the ZOOM/FOCUS setting menu.
8. Move the joystick left, right, up and down to adjust the position of the lens focus, and then press the CAM (SET) button.  
 This completes the adjustment procedure and returns to the zone setting menu.  
 Zoom can be set in a range of 1 to 10 magnifications.

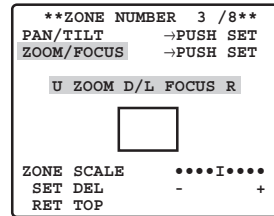

9. Move the cursor to ZONE SCALE, and then tilt the joystick left or right to change the size of the zone frame.  
 Shifting the setting towards the - side makes you frame smaller, while shifting towards the + side makes it larger. Note, that the aspect ratio of the zone frame is always 3:4. Also, the size of the zone frame that can be set changes according to the zoom ratio.
10. Move the cursor to SET, and then press the CAM (SET) button.  
 This completes the privacy zone setting procedure and returns to the zone number selection menu.  
 Selecting DEL instead of SET deletes the zone settings and returns to the zone number selection menu.

### (9) Image Hold Setting (IMAGE HOLD)

Image hold causes the current picture to be frozen until the camera finishes moving to a preset position. This function comes in handy when using a network interface unit for monitoring of camera images over a network.

1. Move the cursor to IMAGE HOLD, and then tilt the joystick left or right to toggle it on and off.  
**ON** : Maintains the last image until the camera finishes moving to a preset position.  
 However, the still image may be distorted with the effect of panning or tilting.  
**OFF** : Picture being picked up by the camera continues to be displayed as the camera moves to a preset position.

### (10) Digital Flip Setting (DIGITAL FLIP)

Normally, a camera needs to stop when it points straight down during tilt. With digital flip, however, the camera is able to tilt from 0° to 180° in a single motion. This makes it possible to track objects passing directly under the camera more smoothly. The picture is flipped vertically and horizontally when the camera is at an angle of around 135°.

1. Move the cursor to DIGITAL FLIP, and then tilt the joystick left or right to toggle it on and off.

**ON** : Turns on digital flip. Note that the tilt range becomes 0° to 90° when ON is selected for the PAN LIMIT setting.

**OFF** : Turns off digital flip. With this setting, the tilt range is 0° to 90°.

#### Notes:

- Digital flip is performed when the joystick is held straight downwards only. It is not performed when the joystick is tilted in any other direction.
- When OFF is selected for DIGITAL FLIP, the following steps need to be performed in order to tilt the camera 180°.
  - (1) Tilt the joystick downwards to point the camera straight down.
  - (2) Tilt the joystick left or right to pan the camera 180°.
  - (3) Tilt the joystick upwards.
- Momentarily turn off DIGITAL FLIP and set the zoom limit to 30x magnification or less before setting a preset position directly from the WV-CU360C System Controller. You can turn these functions back on again after setting the preset position.  
Note that digital flip cannot be specified for the 90° to 180° tilt range.

### (11) Proportional Pan/Tilt Setting (PROPO. P/T)

This function optimizes the image by automatically adjusting the PAN/TILT (horizontal/vertical rotation) speed according to the zoom ratio.

1. Move the cursor to PROPO.P/T, and then tilt the joystick left or right to toggle it on and off.

**ON** : Pan/tilt speed is in inverse proportion to the zoom ratio.

**OFF** : The speed is constant at the fastest level regardless of the zoom ratio.

### (12) Area Title Setting (AREA TITLE)

The area title function lets you display a direction indicator that appears in the picture to indicate the direction of the location being shown on the screen. Text can also be displayed in place of the direction indicators, if desired.

The direction indicators are N (north), NE (northeast), E (east), SE (southeast), S (south), SW (southwest), W (west), and NW (northwest).

1. Move the cursor to AREA TITLE, and then tilt the joystick left or right to turn the area title display function on or off.

**ON (NESW)** : Displays direction indicators.

Selecting ON (NESW) and pressing the CAM (SET) button will display the position (NESW) setting menu, which you can use for configuring detailed settings. (this page)

**ON (USER)** : Displays user input text.

Selecting ON (USER) and pressing the CAM (SET) button will display the area title (USER) selection menu, which you can use for configuring detailed settings. (page 35)

**OFF** : Turns off display of area title direction indicators and text.

- (1) When ON (NESW) is selected

After selecting ON (NESW), you can use the position (NESW) setting menu to configure detailed settings. Once you set the northerly (N) direction for the camera, all other directions are displayed automatically.

1. Move the cursor to →PUSH SET to the right of PAN/TILT, and then press the CAM (SET) button. This will display the PAN/TILT setting menu.

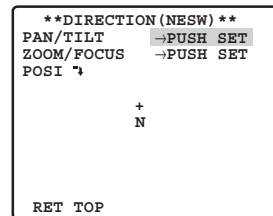

2. Use the joystick to point the camera north, and then press the CAM (SET) button.

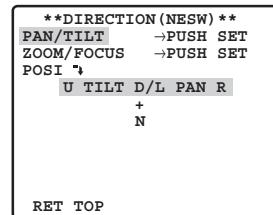

3. Move the cursor to →PUSH SET to the right of ZOOM/FOCUS, and then press the CAM (SET) button. This will display the ZOOM/FOCUS setting menu.

4. Move the joystick left, right, up and down to adjust the position of the lens focus, and then press the CAM (SET) key.

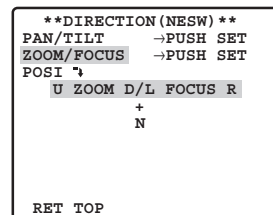

5. Move the cursor to POSI ↵, and then press the CAM (SET) button. This will display the ID position setting menu.

- Use the joystick to select an area title display position, and then press the MON (ESC) button. This registers the area title display position and returns to the area title (NESW) setting menu.

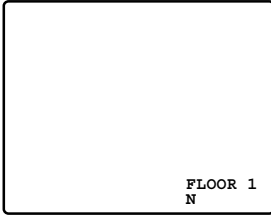

**Note:** The area title is always displayed under the camera ID. If you specify different display position settings for the camera ID and the area title ID, the area title ID display position setting is used for both.

(2) When ON (USER) is selected

After selecting ON (USER), you can use the area title (USER) setting menu to configure detailed settings. You can use the following procedure to configure direction settings, and to input text associated with a particular direction indicator.

- Move the cursor to 1, and then press the CAM (SET) button.

This will display the position setting menu. An asterisk (\*) to the right of an area title number indicates that it already has an area title assigned to it.

If there is already text associated with the direction you selected, it will appear under the cross mark (+). If there is no text associated with the direction, only the cross mark (+) will be displayed.

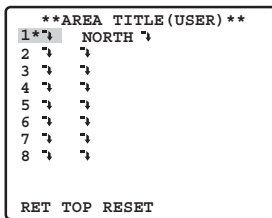

- Adjust the camera orientation (pan and tilt), zoom, and focus.

Perform steps 1 through 4 under "(1) When ON (NESW) is selected" on page 34.

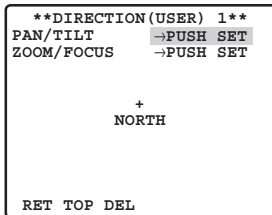

- Move the joystick to the right to align the cursor with the title display, and press the CAM (SET) button. This will display the area title setting menu.

In the example screen shown in step 1, NORTH is the title name of area title number 1.

- Input an area title.

The text input procedure is the same as that for camera ID input.

See steps 3 through 5 under "(1) Camera ID (CAMERA ID)" on page 22 for information about inputting the text for the area title and specifying its position on the display.

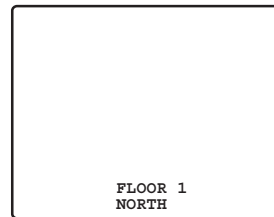
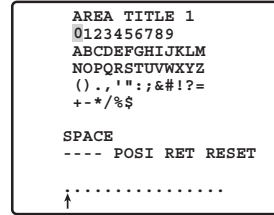

- Repeat steps 1 through 4 for the other area numbers, if you want.

### (13) Tilt Angle Setting (TILT ANGLE)

Selecting 5° for the TILT ANGLE setting allows tilting past horizontal, in the range of -5° to 185°.

- Move the cursor to TILT ANGLE, and then tilt the joystick left or right to toggle the setting between 0° and 5°.

#### Notes:

- Zooming to WIDE while 5° is selected for the TILT angle setting will cause the upper half of the picture to become hidden.
- With certain subjects, AGC (gain control) can cause the image to become white.

### (14) Cleaning Settings (CLEANING)

This camera uses a "slip ring" for transmission of electrical power and signals. A dirty slip ring can cause deterioration of picture quality and generation of noise. The cleaning function performs cleaning approximately once a week to keep the slip ring clean.

- Move the cursor to CLEANING, and then tilt the joystick left or right to toggle it on and off.

The text CLEANING appears in the center of the screen while the cleaning process is being performed.

**Note:** Select OFF for CLEANING before performing an upload or download data with a system device. This protects against the download or upload failure due to start up of the cleaning process.

# ALARM SETTINGS

## ■ Using the Alarm Setup Menu

Display the alarm setup menu from the setup menu to configure alarm settings.

First, display the alarm setup menu.

1. Display the setup menu (page 21), move the cursor to ALARM "↓", and then press the CAM (SET) button. This will display the alarm setup menu.

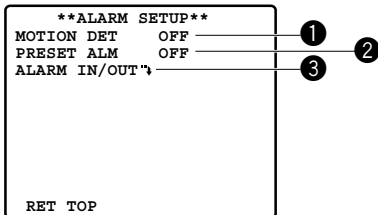

\* The following sections numbered ① to ③ explain how to use each of the alarm setup menu items.

### (1) Motion Detector Setting (MOTION DET)

1. Move the cursor to MOTION DET, and then tilt the joystick left or right to toggle it on and off.

**OFF** : Turns off the motion detector.

**MODE 1** : Alarm signal is output when motion is detected in the image. Selecting MODE 1 and pressing the CAM (SET) button displays the mode 1 setting menu, which can be used for configuring detailed settings.

**MODE 2** : Alarm signal is output when the camera is covered by cloth, a lid, spray paint or something.

### Motion Detector

The motion detector divides the screen into 48 blocks and monitors changes in the luminance in each block. When it detects any change (movement) in the image, it outputs an alarm signal. When a change (movement) in the image is detected while in the auto mode, the alarm signal is output and the camera stops at the preset position for a specified amount of time.

### Important: Conditions for Mode 2

Monitoring might not be possible in the following situations.

- If only one part of the screen is not covered, or if the covering is translucent

Also, false detection might occur in the following situations.

- When extreme changes in lighting occur, such as turning lights on and off
- If pedestrian or vehicle traffic is heavy

**Note:** If you want to set a motion detector for each preset position, do the scene file setting.

## ● Configuring Detailed Motion Detector Settings for MODE 1

1. Move the cursor to MASK SET "↓", and then press the CAM (SET) button. This will display the mask setting screen.

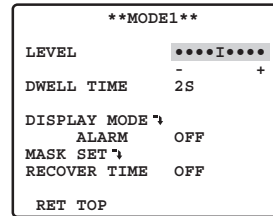

2. Mask the areas of the screen that you do not want the motion detector to monitor for movement.

To mask screen areas, use the same procedure as step 3 under "SUPER-D III (Super Dynamic III)" on page 23. After configuring mask settings, press the MON (ESC) button to return to the motion detector setting menu.

3. Move the cursor to ALARM, and then tilt the joystick left or right to toggle demo mode (see step 5) alarm output on and off.

**ON** : Turns on alarm output in the demo mode.

**OFF** : Turns off alarm output in the demo mode.

4. Move the cursor to DISPLAY MODE, and then press the CAM (SET) button.

This activates the demo mode.

### Demo Mode

The demo mode divides the screen into 48 blocks and monitors changes in the luminance in each block. It also masks any part of the picture where there is a change in average luminance that exceeds the currently specified detection sensitivity level. The demo mode results can be used to determine the optimum detection sensitivity level (step 5) and the areas of the screen that need to be masked (step 1).

5. Move the cursor to LEVEL, and then tilt the joystick left or right to set the detection sensitivity level.

Shifting the setting towards the + side increases sensitivity, while shifting towards the - side decreases it. Repeat steps 4 and 5 until the optimum sensitivity level is obtained.

### Detection Conditions

**Object Size** : The moving object must be larger than one of the screen blocks (1/48 of the total screen area).

**Subject Contrast:** The contrast ratio between the background and the moving object must be at least 5% (at the maximum LEVEL setting).

**Object Speed** : The allowable time range for the object to pass from one edge of the screen to the other is 0.1 second to 0.8 second. Movement that is faster or slower than this cannot be detected.

**Important** : Size and speed limitations are relaxed somewhat when the contrast ratio between the background and the moving object is large.

- Move the cursor to DWELL TIME, and then tilt the joystick left or right to select an alarm detect dwell time setting.

After alarm detection, the next alarm is not detected until the specified dwell time elapses.

Tilting the joystick cycles through the setting display in the sequence shown below. (unit: sec)

2S ↔ 5S ↔ 10S ↔ 30S

- Move the cursor to RECOVER TIME, and then tilt the joystick left or right to select an alarm reset time setting.

Tilting the joystick cycles through the setting display in the sequence shown below. (unit: sec, min)

If you set OFF, then it does not reset until some other operation is done. If AUTO TRACK is set, the camera starts automatic tracking when change (movement) is detected in the image during SEQ or SORT.

OFF ↔ 1MIN ↔ 2MIN ↔ 3MIN ↔ 5MIN ↔ 10MIN

#### Notes:

- Monitoring is usually done in SEQ mode, and when the camera detects change (movement) automatic tracking starts. To have the camera return to SEQ mode after a certain amount of time, set the SELF RETURN setting to SEQ.
- Use the mask setting to mask areas where there is wind movement of curtains, etc.
- Use a lower sensitivity level (LEVEL) setting for areas where illumination is low and prone to digital noise. Also note that operation error can occur when the illuminance of a subject is changed suddenly by the headlights of passing cars, turning lights on or off, etc.
- There is a delay of about 0.2 second from the point that the camera detects change (movement) in the image and the point that a signal is sent to the alarm terminal of a VCR, etc.
- Alarms are not output while the setting menu is displayed, unless demo mode alarm output is turned on.
- Alarms are not output when PAN, TILT, ZOOM, FOCUS or other functions are operating.
- When the motion detector is set to MODE 1 or MODE 2, it outputs alarm data during the blanking period. This can cause operational problems for a VCR or other device that uses a time code signal, etc. Turn off the motion detector when not using coaxial communication.
- The motion detector is not intended for use as specialty device for the prevention of theft, fire, etc. The manufacturer assumes no responsibility for any accidents that occur or any losses incurred while this product is being used.

## (2) Preset Alarm Setting (PRESET ALM)

Turning on the preset alarm will output an alarm from the video output port or alarm output connector when the camera completes a move to a preset position. An alarm is output in the following cases.

- When the self return function is activated (page 30) and the camera finishes moving to the home position, and when switching to the auto mode.
- When SEQ is selected for the auto mode (page 30), and the camera completes a move to a preset position during sequential movement
- When SORT is selected for the auto mode (page 30), and the camera completes a move to a preset position during SORT movement
- When AUTO PAN is selected for the auto mode (page 30), and the camera completes a preset move up to the AUTO PAN start point
- When the camera completes a move to a preset position during manual operation
- When PLAY is selected for the PATROL mode (page 32), and the camera completes a preset move up to the patrol start point

Use the following procedures to configure preset alarm settings

- Move the cursor to PRESET ALM, and then tilt the joystick left or right to toggle it on and off.

**ON** : Turns on the preset alarm function.

**OFF** : Turns off the preset alarm function.

**Note:** Turn off the preset alarm function before downloading or uploading preset data.

## (3) Alarm Input/Output (ALARM IN/OUT)

Use this setting to specify what operation the camera should perform when it an alarm signal is input to the alarm input connector or output from the alarm output connector.

**Note:** While the camera is in the AF mode or the lens moves between WIDE and TELE, alarm input may be ignored if several alarm inputs are received in succession.

- Move the cursor to the ALARM IN/OUT and then press the CAM (SET) button. This will display the alarm setting menu.
- Move the cursor to ALARM IN 1, and then tilt the joystick left and right to select the operation the camera should perform when an external signal is received by ALARM IN 1.

**OFF** : Ignore alarm input signals.

**1POSI** : Move to preset position 1.

**AUTOPAN** : Start auto pan.

**PATROL1** : Start PATROL 1.

**PATROL1 (S)** : Start PATROL 1, and maintain the stored picture quality settings (page 32) even after completion.

**AUTOTRACK1** : Move to preset position number 1, and then perform auto tracking.

**ALARM IN/OUT**	
ALARM IN1	OFF
ALARM IN2	OFF
ALARM IN3	OFF
ALARM IN4	OFF
CNT-CLS 1	OFF
TIME OUT	100MS
CNT-CLS 2	OFF
COAX ALM OUT	OFF
RET TOP	

3. Move the cursor to ALARM IN 2, and then tilt the joystick left and right to select the operation the camera should perform when an external signal is received by ALARM IN 2.

**OFF** : Ignore alarm input signals.  
**2POSI** : Move to preset position 2.  
**SEQ** : Start sequential movement.  
**PATROL2** : Start PATROL 2.  
**PATROL2 (S)** : Start PATROL 2, and maintain the stored picture quality settings (page 32) even after completion.

**AUTOTRACK2** : Move to preset position number 2, and then perform auto tracking.

4. Move the cursor to ALARM IN 3, and then tilt the joystick left and right to select the operation the camera should perform when an external signal is received by ALARM IN 3.

**OFF** : Ignore alarm input signals.  
**3POSI** : Move to preset position 3.  
**SORT** : Start sort movement.  
**PATROL3** : Start PATROL 3.  
**PATROL3 (S)** : Start PATROL 3, and maintain the stored picture quality settings (page 32) even after completion.

**AUTOTRACK3** : Move to preset position number 3, and then perform auto tracking.

5. Move the cursor to ALARM IN 4, and then tilt the joystick left and right to select the operation the camera should perform when an external signal is received by ALARM IN 4.

**OFF** : Ignore alarm input signals.  
**4POSI** : Move to preset position 4.  
**BW** : Black and white display while signal is being input.  
**PATROL4** : Start PATROL 4.  
**PATROL4 (S)** : Start PATROL 4, and maintain the stored picture quality settings (page 32) even after completion.

**AUTOTRACK4** : Move to preset position number 4, and then perform auto tracking.

**Notes:**

- Use PATROL 1 (S) to 4 (S) if you want to switch picture quality (for example to switch picture quality from day to night) when an alarm input is received. ALARM IN4 can be used combined with BW. To use the camera with this application, set the picture quality you want to switch before registering the patrol, then start the patrol registration and then end the registration immediately.
- If you want to change the picture quality settings according to alarm input for PATROL 1 (S) to 4 (S), the settings are applied to the camera settings and are kept even after the camera is turned on again.
- PATROL1(S)-4(S) displays only the set number of patrol routines (page 32).

6. Move the cursor to CNT-CLS 1, and then tilt the joystick left and right to select the alarm output that should be performed over ALARM OUT 1 when an alarm is detected.

**OFF** : No alarm output  
**ALARM** : Output an alarm signal when an alarm is detected by the motion detector (page 36) or the preset alarm (page 37). After selecting this setting, perform step 7 to specify the alarm signal output time.  
**AUX1** : Output a contact close signal when AUX1 input is received from the system controller.

7. If you selected ALARM in step 6, move the cursor to TIME OUT and then tilt the joystick left and right to select the alarm signal output time. Tilting the joystick cycles through the output time display in the sequence shown below. (unit: ms)

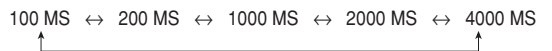

**Note:** The shorter the duration, the more frequent will be the detection output.

8. Move the cursor to CNT-CLS 2, and then tilt the joystick left and right to select the alarm output that should be performed from ALARM OUT 2 when an alarm is detected.

**OFF** : No alarm output  
**BW** : Output a contact close signal only while the camera is in the black and white mode.  
**AUX2** : Output a contact close signal when AUX2 input is received from the system controller.

**Note:** It is recommended to set the connected external device to ignore the shorter alarm outputs of 90 ms or less from the camera.

9. Move the cursor to COAX ALM OUT, and then tilt the joystick left or right to toggle it on and off. This setting turns alarm controls whether an alarm is output when the camera moves to one of the preset positions specified for ALARM IN 1 through 4 (1POSI, 2POSI, 3POSI, 4POSI) in steps 2 through 5, above.

**ON** : Output an alarm signal from the video output connector at the point the camera finishes moving to a preset position (number 1 through 4) when there is alarm input to ALARM IN (1 through 4).  
**OFF** : No alarm signal output

**Notes:**

- The camera ignores alarm inputs during manual operation.
- Turn off alarm outputs before downloading or uploading preset data.

# SPECIAL SETTINGS

## ■ Using the Special Setup Menu

Display the special setup menu from the setup menu to adjust picture quality.

First, display the special setup menu.

1. Display the setup menu (page 21), move the cursor to SPECIAL "↵", and then press the CAM (SET) button.

This will display the special setup menu.

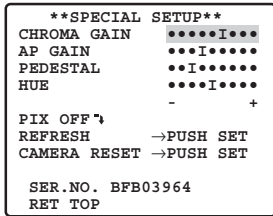

## ● Adjusting Picture Quality

Use the following procedure to adjust picture quality.

1. Move the cursor to CHROMA GAIN, and then tilt the joystick left or right to adjust the CHROMA GAIN level.
2. Move the cursor to AP GAIN, and then tilt the joystick left or right to adjust the aperture level.
3. Move the cursor to PEDESTAL, and then tilt the joystick left or right to adjust the PEDESTAL level.
4. Move the cursor to HUE, and then tilt the joystick left or right to adjust the chroma phase (color tone).
5. Move the cursor to PIX OFF "↵", and then press the CAM (SET) button.

This will display the PIX OFF menu. Perform the following steps to perform blemish compensation on the pixels.

6. Select a position that has a blemish with the PIX OFF number, and then press the CAM (SET) button. This will display the blemish compensation pattern setting screen.

- (1) Use the joystick to move the cross cursor (+) to the location of the defective pixels.
- (2) Move the cursor around the display until there are no more white spots (blemishes) visible, and then press the CAM (SET) button. This will store the blemish compensation pattern.
- (3) This returns to the PIX OFF menu.

An asterisk (\*) to the right of a PIX OFF number indicates that the number has a blemish compensation pattern assigned to it.

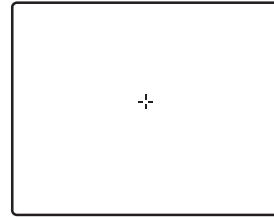
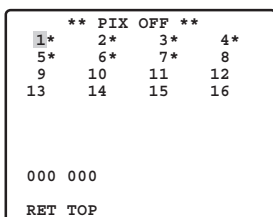

### To delete a blemish compensation pattern

- (1) On the PIX OFF menu screen, select of the pattern you want to delete, and press the CAM (SET) button.

This will display the blemish compensation pattern setting screen.

- (2) Press the F3 button.
- (3) This returns to the PIX OFF menu.

This will delete the blemish compensation pattern and remove the asterisk (\*) to the right of the applicable pattern number.

7. To correct for camera deviation from the preset positions during operation, move the cursor to →PUSH SET to the right of REFRESH, and then press the F3 button.

The refresh function corrects the camera position when it starts to deviate from the preset positions.

8. To reset the camera to its initial default settings, move the cursor to →PUSH SET to the right of CAMERA RESET, and then press the F4 button.

This resets the camera to its initial factory default settings. Note, however, that this does not change the camera's preset position, AUTO PAN, patrol, RS485, blemish compensation patten and password settings.

**Note:** If above operations are performed while the cursor is located at any other item besides CAMERA RESET, further menu operations may become impossible. If this happens, use the procedure under "Displaying the Setup Menu" on page 21 to re-display the menu.

# SCENE SELECT SETTING

## ■ Using the Scene Select Setting Menu

Display the scene select setting menu from the setup menu to configure scene select settings. First, display the scene select setting menu.

1. Display the setup menu (page 21), move the cursor to SCENE SELECT "↓", and then press the CAM (SET) button.

This will display the scene select setting menu.

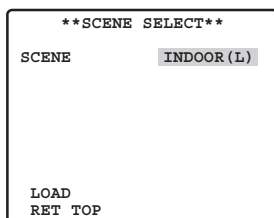

## ● Scene Select Settings

Use the following procedure to configure scene select settings.

1. Move the cursor to SCENE, and then tilt the joystick left or right to change the scene setup.

- INDOOR (L)** : Indoor setting (picture quality priority)
- INDOOR (H)** : Indoor setting (sensitivity priority)
- OUTDOOR (L)** : Outdoor setting (picture quality priority)
- OUTDOOR (H)** : Outdoor setting (sensitivity priority)

**Note:** The camera cannot be installed outside.

Settings related to the picture switch depending on the scene settings. Scene select settings and relationship to other settings are shown in the table below.

	AGC	SENS UP	SHUTTER	BW	DNR	WHITE BAL
INDOOR (L)	MID	OFF	OFF	OFF	LOW	ATW1
INDOOR (H)	HIGH	×2 AUTO	OFF	OFF	HIGH	ATW1
OUTDOOR (L)	MID	OFF	AUTO	AUTO	LOW	ATW2
OUTDOOR (H)	HIGH	×2 AUTO	AUTO	AUTO	HIGH	ATW2

2. Move the cursor to LOAD, and then press the CAM (SET) button.

This will cause the setup you selected for SCENE in step 1 to be applied to the image.



## ■ Displaying the Quick Setup Menu

The quick setup menu can be displayed from the setup menu.

1. Display the setup menu (page 21), move the cursor to → QUICK SETUP, and then press the CAM (SET) button.

Only the following items can be set on the quick setup menu.

- Camera ID setting (page 22)
- Scene select settings (page 40)
- Preset position settings (page 27)
- Language settings (page 21)

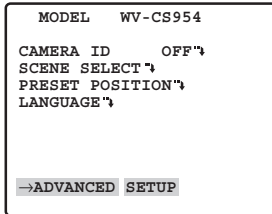

The procedures for configuring settings using the quick setup menu are the same as those for the detailed menu.

To switch back to the detailed menu from the quick setup menu, move the cursor to →ADVANCED SETUP, and then press the CAM (SET) button.

# PASSWORD SETTINGS

## ■ Password Lock Settings

Set the password lock on the setup menu.

### ● Turning Password Lock On and Off

The password lock function can be used to allow only authorized personnel to change camera settings. A password must be input in order to turn password lock on or off.

**ON** : Prohibits changing any settings except for the password lock function.

Selecting this setting limits camera configuration changes to authorized personnel.

**OFF** : Settings on all menus can be changed.

If you are using a VCR for recording, turn off recording before inputting the password. Inputting the password while the picture is being recorded by a VCR will cause the password to be recorded with the picture.

1. Display the setup menu (page 21), move the cursor to PASSWORD LOCK (ON or OFF), and then press the CAM (SET) button.

This will display the password input menu.

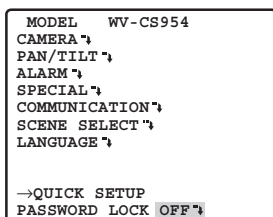

2. To set the password for the first time, enter the factory default password "123" and then press the CAM (SET) button.

**Note:** You must use this procedure. The password Lock ON/OFF does not switch.

3. Input a 3-digit password by moving the cursor to each of the applicable numbers along the top of the screen (0 to 9) and pressing the CAM (SET) button for each digit.

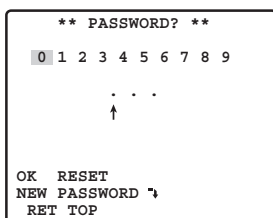

The ↑ pointer will move to the right each time you input a digit. After you input all three digits, move the cursor to OK.

If you make a mistake during input, move the cursor to RESET, press the CAM (SET) button, and then re-input the entire password.

**Note:** The factory default password is 123.

4. Press the CAM (SET) button.  
This returns to the setup menu and toggles PASSWORD LOCK on or off.

The password input screen will reappear if you press the CAM (SET) button after inputting the wrong password. If this happens, perform steps 2 and 3 again.

### ● Changing the Password

After turning on password lock, it is recommended that you use the following procedure to change the factory default password to a different one. Also, make sure you keep a separate record of your password so you do not forget it.

If you are using a VCR for recording, turn off recording before inputting the password. Inputting the password while the picture is being recorded by a VCR will cause the password to be recorded with the picture.

1. Display the setup menu (page 21), move the cursor to PASSWORD LOCK (ON or OFF), and then press the CAM (SET) button.

This will display the password input menu.

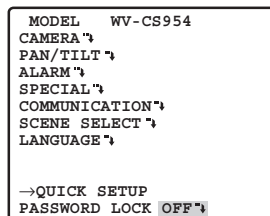

2. Input the current 3-digit password by moving the cursor to each of the applicable numbers along the top of the screen (0 to 9) and pressing the CAM (SET) button for each digit.

The ↑ pointer will move to the right each time you input a digit. After you input all three digits, move the cursor to OK.

If you make a mistake during input, move the cursor to RESET, press the CAM (SET) button, and then re-input the entire password.

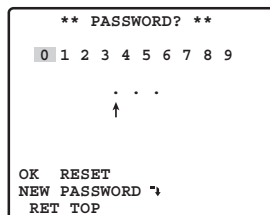

3. Move the cursor to NEW PASSWORD and press the CAM (SET) button to display the password setting menu.  
The password input screen will reappear if you press the CAM (SET) button after inputting the wrong password. If this happens, perform steps 2 and 3 again.
4. Input the new 3-digit password by moving the cursor to each of the applicable numbers along the top of the screen (0 to 9) and pressing the CAM (SET) button for each digit.  
After you input all three digits, move the cursor to OK.

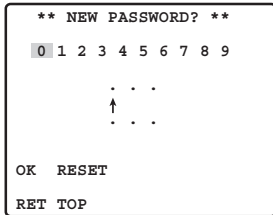

5. Press the CAM (SET) button.  
This returns to the new password input screen again for verification.  
Note that you cannot register the new password by pressing the MON (ESC) button.
6. Input the new 3-digit password again by moving the cursor to each of the applicable numbers along the top of the screen (0 to 9) and pressing the CAM (SET) button for each digit.  
After you input all three digits, move the cursor to OK.
7. Press the CAM (SET) button.  
This completes the password change operation and returns to the setup menu. If the new password you input in step 6 is different from the one you input in step 4, the new password input screen will appear again. If this happens, perform steps 4 through 7 again. Note that you cannot register the new password by pressing the MON (ESC) button.

## SHORTCUTS

Shortcuts are supported when you are using the system controller that has a CAM FUNCTION button. With shortcuts, you can configure camera functions by inputting function codes on the 10-key pad and then pressing the CAM FUNCTION button.

The following is a list of all of the shortcuts that are supported by this camera. In addition, you can also move the camera to a preset position by inputting the applicable position number on the 10-key pad.

### Notes:

- Turn off digital flip before registering preset positions. If NO REGS.; FLIP ON appears, do the setting again.
- Shortcuts may not be performed if they are executed while a pan, tilt, zoom, or focus operation is in progress.
- Shortcuts 1 through 64, 169, 170, and 301~556 can be saved as part of a patrol routine.
- Except for shortcuts 169 and 170, executing any shortcut during patrol routine PLAY will cause the PLAY operation to stop.

Controller Operation	Setting
[6] + [5] + [CAM FUNCTION]	AUTO PAN ON
[6] + [6] + [CAM FUNCTION]	AUTO PAN OFF
[6] + [7] + [CAM FUNCTION]	Increases AUTO PAN speed one step.
[6] + [8] + [CAM FUNCTION]	Decreases AUTO PAN speed one step.
[6] + [9] + [CAM FUNCTION]	Sets AUTO PAN start point.
[7] + [0] + [CAM FUNCTION]	Sets AUTO PAN end point.
[7] + [1] + [CAM FUNCTION]	AUTO MODE: OFF
[7] + [2] + [CAM FUNCTION]	AUTO MODE: SEQ ON
[7] + [3] + [CAM FUNCTION]	AUTO MODE: SORT ON
[7] + [4] + [CAM FUNCTION]	Reverses AUTO PAN range.
[7] + [6] + [CAM FUNCTION]	ENDLESS: ON
[7] + [7] + [CAM FUNCTION]	ENDLESS: OFF
[7] + [8] + [CAM FUNCTION]	DIGITAL FLIP: ON
[7] + [9] + [CAM FUNCTION]	DIGITAL FLIP: OFF
[8] + [0] + [CAM FUNCTION]	PROPO.P/T: ON
[8] + [1] + [CAM FUNCTION]	PROPO.P/T: OFF
[8] + [4] + [CAM FUNCTION]	SUPER-D III: ON
[8] + [5] + [CAM FUNCTION]	SUPER-D III: OFF
[8] + [6] + [CAM FUNCTION]	AF MODE: AUTO
[8] + [7] + [CAM FUNCTION]	AF MODE: MANUAL
[8] + [8] + [CAM FUNCTION]	Performs auto focus.
[8] + [9] + [CAM FUNCTION]	Moves to home position.
[9] + [0] + [CAM FUNCTION]	BW: ON
[9] + [1] + [CAM FUNCTION]	BW: OFF
[9] + [2] + [CAM FUNCTION]	BW: AUTO
[9] + [3] + [CAM FUNCTION]	CAMERA ID: ON
[9] + [4] + [CAM FUNCTION]	CAMERA ID: OFF
[9] + [5] + [CAM FUNCTION]	AREA TITLE: ON (NESW)
[9] + [6] + [CAM FUNCTION]	AREA TITLE: ON (USER)
[9] + [7] + [CAM FUNCTION]	AREA TITLE: OFF
[1] + [0] + [0] + [CAM FUNCTION]	Adjusts camera position (REFRESH)
[1] + [0] + [1] + [CAM FUNCTION]~	Registers a position to a preset number (1 to 64).
[1] + [6] + [4] + [CAM FUNCTION]	
[1] + [6] + [5] + [CAM FUNCTION]	PATROL1: PLAY
[1] + [6] + [6] + [CAM FUNCTION]	PATROL 1 - PATROL 4: STOP
[1] + [6] + [7] + [CAM FUNCTION]	PATROL1: LEARN start
[1] + [6] + [9] + [CAM FUNCTION]	IRIS: OPEN

Controller Operation	Setting
[1] + [7] + [0] + [CAM FUNCTION]	IRIS: CLOSE
[1] + [7] + [1] + [CAM FUNCTION]	SHUTTER: ON
[1] + [7] + [2] + [CAM FUNCTION]	SHUTTER: OFF
[1] + [7] + [3] + [CAM FUNCTION]	Increases shutter speed one step.
[1] + [7] + [4] + [CAM FUNCTION]	Decreases shutter speed one step.
[1] + [7] + [5] + [CAM FUNCTION]	AGC: ON
[1] + [7] + [6] + [CAM FUNCTION]	AGC: OFF
[1] + [7] + [7] + [CAM FUNCTION]	SENS UP: FIX ON
[1] + [7] + [8] + [CAM FUNCTION]	SENS UP: FIX OFF
[1] + [7] + [9] + [CAM FUNCTION]	Increases electronic sensitivity enhancement (FIX) one step.
[1] + [8] + [0] + [CAM FUNCTION]	Decreases electronic sensitivity enhancement (FIX) one step.
[1] + [8] + [1] + [CAM FUNCTION]	SENS UP: AUTO ON
[1] + [8] + [2] + [CAM FUNCTION]	SENS UP: AUTO OFF
[1] + [8] + [3] + [CAM FUNCTION]	Increases electronic sensitivity enhancement (AUTO) one step.
[1] + [8] + [4] + [CAM FUNCTION]	Decreases electronic sensitivity enhancement (AUTO) one step.
[1] + [8] + [5] + [CAM FUNCTION]	Increases line lock phase (FINE) one step.
[1] + [8] + [6] + [CAM FUNCTION]	Decreases line lock phase (FINE) one step.
[1] + [8] + [7] + [CAM FUNCTION]	Pans 180° .
[1] + [8] + [8] + [CAM FUNCTION]	CLEANING: ON
[1] + [8] + [9] + [CAM FUNCTION]	CLEANING: OFF
[1] + [9] + [0] + [CAM FUNCTION]	BW AUTO switching time: 10 seconds
[1] + [9] + [1] + [CAM FUNCTION]	BW AUTO switching time: 30 seconds
[1] + [9] + [2] + [CAM FUNCTION]	BW AUTO switching time: 60 seconds
[1] + [9] + [3] + [CAM FUNCTION]	BW AUTO switching time: 300 seconds
[1] + [9] + [4] + [CAM FUNCTION]	PATROL2: PLAY
[1] + [9] + [5] + [CAM FUNCTION]	PATROL3: PLAY
[1] + [9] + [6] + [CAM FUNCTION]	PATROL4: PLAY
[1] + [9] + [7] + [CAM FUNCTION]	PATROL2: LEARN start
[1] + [9] + [8] + [CAM FUNCTION]	PATROL3: LEARN start
[1] + [9] + [9] + [CAM FUNCTION]	PATROL4: LEARN start
[2] + [0] + [0] + [CAM FUNCTION]	Turns on auto tracking.
[2] + [0] + [1] + [CAM FUNCTION]	STABILIZER: ON
[2] + [0] + [2] + [CAM FUNCTION]	STABILIZER: OFF
[2] + [0] + [3] + [CAM FUNCTION]	PAN, TILT, ZOOM, coordinate display ON
[2] + [0] + [4] + [CAM FUNCTION]	PAN, TILT, ZOOM, coordinate display OFF
[3] + [0] + [1] + [CAM FUNCTION]~	Moves to a preset number (1 to 256).*
[5] + [5] + [6] + [CAM FUNCTION]	Example: Preset number 128 → [4] + [2] + [8] + [CAM FUNCTION]
[6] + [0] + [1] + [CAM FUNCTION]~	Registers a position to a preset number (1 to 256).*
[8] + [5] + [6] + [CAM FUNCTION]	Example: Preset number 128 → [7] + [2] + [8] + [CAM FUNCTION]

\* Do not do this operation with the previous dome type camera models (WV-CS850 series, WV-CS854, WV-CS854E series, WV-CW860 series, WV-CW864, WV-CW864E series, and WV-CS564), doing so may cause a malfunction.

# TROUBLESHOOTING

Before requesting service, check the following symptoms to see if you can solve the problem yourself. If the countermeasures described below do not correct the problem, or if the symptoms you are experiencing are not covered here, contact a quality service person or system installer.

Problem	Cause and Recommended Action	Reference Pages
<b>No picture (dark screen)</b>	<ul style="list-style-type: none"> <li>Is the camera connected correctly? Check the operating instructions that come with your system controller.</li> </ul>	—
	<ul style="list-style-type: none"> <li>Is the lens iris closed? Execute the iris reset from the system controller you are using.</li> </ul>	<b>22-23</b>
	<ul style="list-style-type: none"> <li>Is the camera set up for a fixed shutter speed?</li> </ul>	<b>23</b>
<b>White picture</b>	<ul style="list-style-type: none"> <li>Is the lens iris open?</li> </ul>	<b>22-23</b>
	<ul style="list-style-type: none"> <li>Is FIX selected for the electronic sensitivity enhancement (SENS UP) setting?</li> </ul>	<b>24</b>
<b>Out of focus picture</b>	<ul style="list-style-type: none"> <li>Is the dome cover or lens of the camera dirty? If so, clean them.</li> </ul>	<b>7</b>
	<ul style="list-style-type: none"> <li>Is MANUAL selected for the auto focus mode?</li> </ul>	<b>26</b>
	<ul style="list-style-type: none"> <li>Is the object one that is not compatible with auto focus? For such objects, focus manually.</li> </ul>	<b>26</b>
<b>Digital noise in the picture</b>	<ul style="list-style-type: none"> <li>The slip ring may be dirty. Do you have the cleaning function turned on?</li> </ul>	<b>35</b>
	<ul style="list-style-type: none"> <li>Is the camera set up correctly?</li> </ul>	<b>11</b>

Problem	Cause and Recommended Action	Reference Pages
<b>Poor picture color</b>	<ul style="list-style-type: none"> <li>• Check the white balance setting.</li> </ul>	<b>25</b>
	<ul style="list-style-type: none"> <li>• Use the special setup menu to adjust picture quality.</li> </ul>	<b>39</b>
	<ul style="list-style-type: none"> <li>• Is the dome cover or lens of the camera dirty? If so, clean them.</li> </ul>	<b>7</b>
<b>Image flicker</b>	<ul style="list-style-type: none"> <li>• If Super Dynamic III is turned on, turn it off.</li> </ul>	<b>22-23</b>
<b>Afterimages in the picture</b>	<ul style="list-style-type: none"> <li>• Check the DNR setting.</li> </ul>	<b>25</b>
<b>Black and white picture picture</b>	<ul style="list-style-type: none"> <li>• The camera has an auto black and white switching mode function. Check the setting of this mode.</li> </ul>	<b>25-26</b>
<b>Frequent switching between the color and the black and white modes</b>	<ul style="list-style-type: none"> <li>• Adjust the black and white mode switching level, and the duration time setting.</li> </ul>	<b>25-26</b>
<b>White specks in the picture</b>	<ul style="list-style-type: none"> <li>• Use the PIX OFF function to perform blemish compensation.</li> </ul>	<b>39</b>
<b>Menu does not open.</b>	<ul style="list-style-type: none"> <li>• Is the camera connected correctly? See the operating instructions that come with the system controller you are using.</li> </ul>	<b>—</b>
	<ul style="list-style-type: none"> <li>• Are camera communication settings configured correctly?</li> </ul>	<b>12-14</b> <b>18-19</b> <b>20</b>

Problem	Cause and Recommended Action	Reference Pages
<p><b>Menu settings will not change.</b></p>	<ul style="list-style-type: none"> <li>• Is the password lock function turned on?</li> </ul>	<p><b>42</b></p>
<p><b>I forgot the password.</b></p>	<ul style="list-style-type: none"> <li>• Contact a quality service person or system installer.</li> </ul>	<p>—</p>
<p><b>Picture does not switch to black and white.</b></p>	<ul style="list-style-type: none"> <li>• Switching is not performed when the ALARM IN 4 setting is BW. Check the setting.</li> </ul>	<p><b>38</b></p>
<p><b>Pan, tilt, zoom, or focus do not work.</b></p>	<ul style="list-style-type: none"> <li>• Is the camera connected correctly? See the operating instructions that come with the system controller you are using.</li> </ul>	<p>—</p>
	<ul style="list-style-type: none"> <li>• The camera has a pan limit function. Check the PAN LIMIT settings.</li> </ul>	<p><b>31</b></p>
	<ul style="list-style-type: none"> <li>• The motor or lens may be worn. Contact a quality service person or system installer.</li> </ul>	<p>—</p>
<p><b>The camera movement modes (OFF, SEQ, SORT, AUTO PAN, PATROL, AUTO TRACK) do not work.</b></p>	<ul style="list-style-type: none"> <li>• Check the self return function.</li> </ul>	<p><b>30</b></p>
	<ul style="list-style-type: none"> <li>• Check the ALARM IN settings.</li> </ul>	<p><b>37-38</b></p>
	<ul style="list-style-type: none"> <li>• Check the recover time setting of the motion detector.</li> </ul>	<p><b>36-37</b></p>



Problem	Cause and Recommended Action	Reference Pages
<p>The camera movement mode (OFF, SEQ, SORT, AUTO PAN, PATROL, AUTO TRACK) setting changes.</p>	<ul style="list-style-type: none"> <li>• Check the self return function.</li> </ul>	<p><b>30</b></p>
<p>Camera position is different from the preset position setting.</p>	<ul style="list-style-type: none"> <li>• Perform REFRESH from the special setup menu.</li> </ul>	<p><b>39</b></p>
<p>Picture is different from the position setting.</p>	<ul style="list-style-type: none"> <li>• Adjust the picture using the preset menu and a scene file.</li> </ul>	<p><b>27-29</b></p>
<p>Upper part of the picture is black when the camera is in a horizontal orientation.</p>	<ul style="list-style-type: none"> <li>• This is caused by the camera's internal cover. It does not indicate malfunction.</li> </ul>	<p><b>35</b></p>
<p>Camera suddenly starts to pan by itself.</p>	<ul style="list-style-type: none"> <li>• If the cleaning function is turned on, this is normal does not indicate malfunction. Check the CLEANING settings.</li> </ul>	<p><b>35</b></p>
	<ul style="list-style-type: none"> <li>• If the cleaning function is not turned on, this symptom could be due to noise.</li> </ul>	<p><b>8, 12</b></p>

● **Periodically check the power cord and plug.**

<p>Power cord sheathing is damaged.</p>	<ul style="list-style-type: none"> <li>• The power cord, connector, or power plug is damaged. Continued use creates the risk of electric shock and fire. Immediately unplug the power plug and contact a qualified service person or system installer for servicing.</li> </ul>
<p>Power cord, connectors, or power plug becomes hot during operation.</p>	
<p>Power cord becomes warm or hot when it is bent or stretched during use.</p>	

# SPECIFICATIONS

## ● General

Power Requirements	24 V AC, 60 Hz
Power Consumption	13 W
Pick-up Device	1/4-type {1/4"} interline transfer CCD
Effective Pixels	768 (H) × 494 (V)
Scanning Area	3.65 mm (H) × 2.74 mm (V)
Signal	NTSC
Synchronization	Internal (INT), multiplexed vertical drive (VD2), link-lock (LL)
Scanning	2:1 interlace
Scanning Frequencies	Horizontal: 15.734 kHz, Vertical: 59.94 Hz
Video Output	VBS: 1.0 V [P-P]/75 Ω (BNC plug)
Resolution (Center)	Horizontal : 480 lines minimum (color NORMAL mode) 540 lines typ. , 520 lines minimum (color HIGH mode) 570 lines minimum (black and white) Vertical : 350 lines minimum (Center)
Minimum Illumination	0.5 lux{fc} (color mode) 0.04 lux{fc} (black and white mode) SENS UP: OFF; AGC: HIGH
Dynamic Range	52 dB typ. (SUPER-DⅢ: ON)
S/N Ratio	50 dB minimum (AGC: OFF)
Ambient Operating Temperature	-10 °C to 50 °C; Humidity 90 % max. (non-condensation)
Dimensions	154.5 mm(D) × 233 mm(H) {6-5/64"(D) × 9-11/64"(H)}
Weight	Approximately 2.2 kg {4.9 lbs}
Finish	Camera: Die cast aluminum with baked melanin coating (Paint color: Fine silver) Dome: Clear acrylic resin

## ● Pan and Tilt

Panning Range	360 ° endless
Panning Modes	Manual, auto, manual position, sequential position
Panning Speed*	Manual: Approximately 0.065 °/s to 120 °/s 8 steps, 16 steps, 64 steps Preset: Approximately 400 °/s
Tilting Range	-5 ° to 185 ° (horizontal - vertical - horizontal) (According to the TILT ANGLE)
Tilting Modes	Manual, manual position, sequential position
Tilting Speed*	Manual: Approximately 0.065 °/s to 120 °/s 8 steps, 16 steps, 64 steps Preset: Approximately 400 °/s

\* Actual speed depends on type of controller being used.

## ● Lens

Zoom Ratio	30x (Approximately 300x with digital zoom)
Focal Length	3.8 mm to 114 mm
Maximum Aperture Ratio	1:1.4 (WIDE) to 3.7 (TELE)
Object Distance	1.5 m
Iris Range	F1.4 to 22, Close
Angular Field of View	Horizontal: 1.9 ° (TELE) to 52 ° (WIDE) Vertical: 1.4 ° (TELE) to 40 ° (WIDE)

## ● Main Functions

Controller Interface	Coaxial Multiplex System, RS485
Control Functions	Pan and tilt, zoom and focus, 256 preset positions, home position, patrol
AGC	ON (LOW), ON (MID), ON (HIGH), OFF
Title (ID)	ON, OFF (Preset ID, camera ID, area title: 16 alphanumeric characters)
Zoom Speed	Approximately 6.0 seconds (TELE to WIDE) in manual mode
Zoom Limit	1x to 300x (Over 30x is electronic zoom)
Password Lock	All menus
Auto Focus	MANUAL/AUTO (PAN, TILT, ZOOM linked)
Iris	ALC (Adjustable OPEN/CLOSE output target level)/MANUAL
Shutter	OFF (1/60), AUTO, 1/100, 1/250, 1/500, 1/1000, 1/2000, 1/4000, 1/10000
Electronic Sensitivity Enhancement	32X max. (AUTO or FIX)
Auto Mode	OFF, SEQ, SORT, AUTO PAN, PATROL, AUTO TRACK
Auto Pan Key	SEQ, SORT, AUTO PAN, PATROL, AUTO TRACK
Digital Flip	ON/OFF
SUPER-D III	ON/OFF
Motion Detector	OFF/MODE1/MODE2
Alarm Input/Output	4 inputs (ALARM IN 1 to ALARM IN 4) 2 outputs (ALARM/AUX1, BW/AUX2)
Black and White Mode Switching	AUTO/ON/OFF
Privacy Zone	ON/OFF (8 zone settings)
Patrol	STOP/PLAY/LEARN
Cleaning	ON/OFF
Image Hold	ON/OFF
Auto Image Stabilizer	ON/OFF
Scene Select Setting	INDOOR (L) /INDOOR (H) /OUTDOOR (L) /OUTDOOR (H)
Language Setting	Japanese, English, German, French, Italian, Spanish, Russian, Chinese

**Panasonic System Solutions Company,**  
Unit Company of Panasonic Corporation of North America

**Security Systems**

[www.panasonic.com/security](http://www.panasonic.com/security)

For customer support, call 1.877.733.3689

**Executive Office:** Three Panasonic Way 2H-2, Secaucus, New Jersey 07094

**Zone Office**

**Eastern:** Three Panasonic Way, Secaucus, New Jersey 07094

**Central:** 1707 N. Randal Road, Elgin, IL 60123

**Southern:** 1225 Northbrook Parkway, Suwanee, GA 30024

**Western:** 6550 Katella Ave., Cypress, CA 90630

**Panasonic Canada Inc.**

5770 Ambler Drive, Mississauga,  
Ontario, L4W 2T3 Canada (905)624-5010  
<http://www.panasonic.ca>

**Panasonic Sales Company**

**Division of Panasonic Puerto Rico Inc.**

San Gabriel Industrial Park 65th Infantry Ave. KM. 9.5 Carolina,  
P.R. 00985 (809)750-4300